

EXOWELD *Welded Electrical Connections*

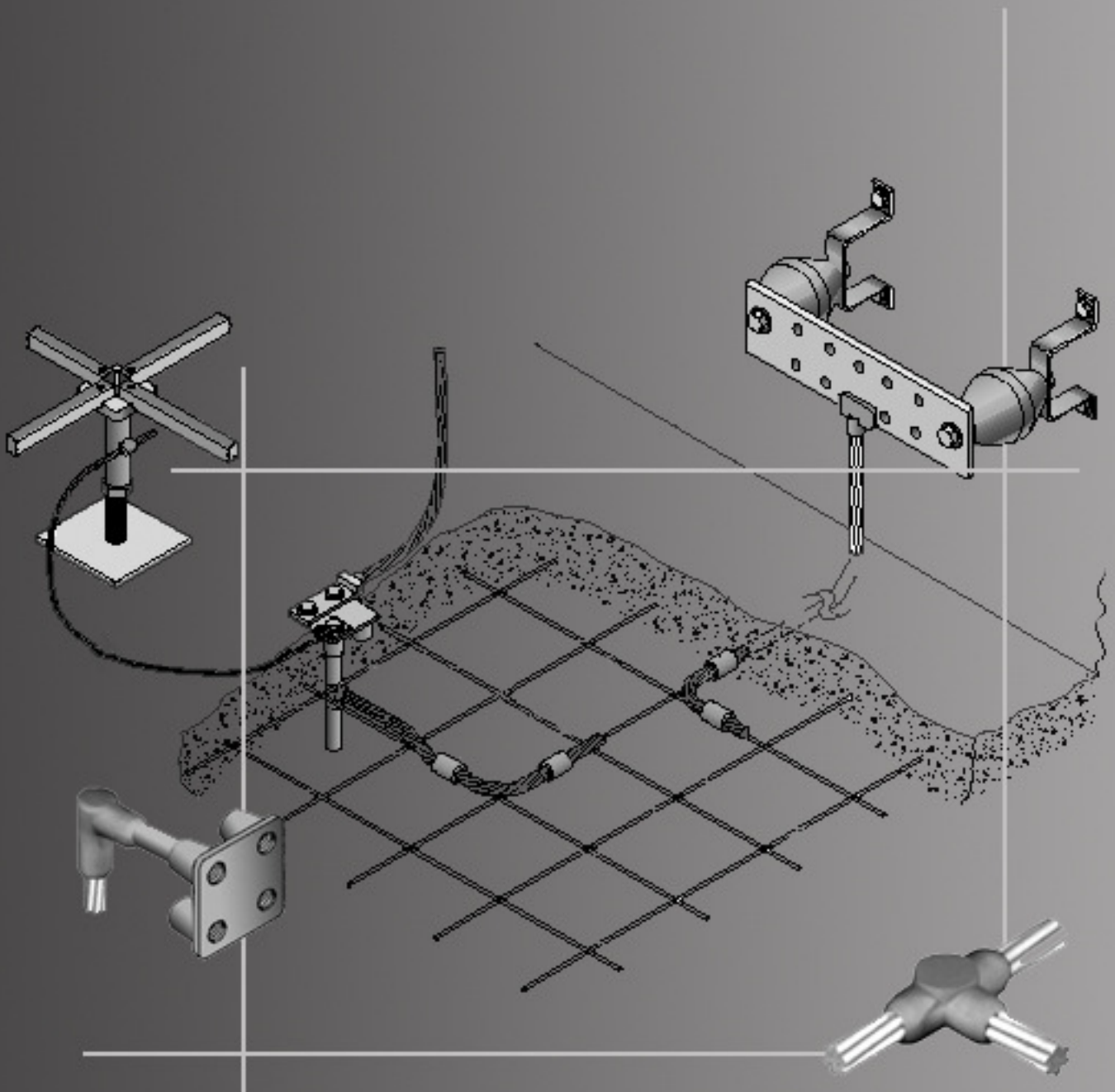

INTRODUCTION

What is EXOWELD ?

EXOWELD is the brand name of exothermic materials which are manufactured by Korea EMI Technologies co, Ltd.

EXOWELD Exothermic welding is a cost effective method of completing a high quality electrical connection. The process is simple to follow and through the use of a high temperature reaction a long lasting, quality electrical bond is created between conductors.

Making an EXOWELD Connection

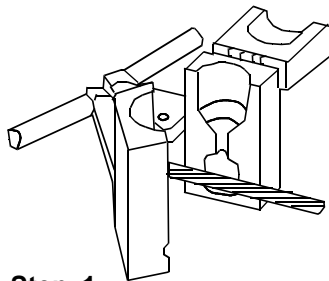

Step 1
Clean the conductors to be welded.
Place the cables into position in the mold.

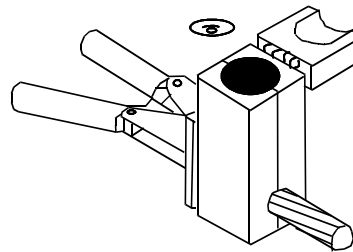

Step 2
Close the handle clamp to lock the mold.
Place the disk into position in the mold.

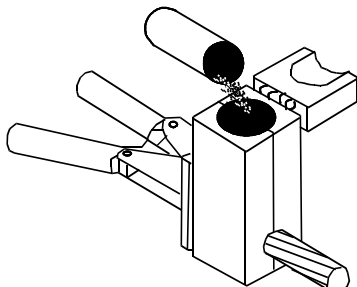

Step 3
Place the weld metal into the mold.
Sprinkle the starting powder over the
weld metal and on the lip of the mold.

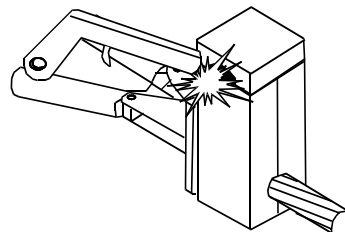

Step 4
Close the cover and ignite using flint ignitor.
Open the mold after the metal solidifies.
Remove the slag from the mold before
making the next connection.

Advantages

1. Does not deteriorate with age since the connections are permanent.
2. Does not loosen as the ThunderWeld connections create a permanent molecular bond.
3. Excellent corrosion resistance.
4. Electrical characteristics are higher than typical mechanical connections.
5. Does not increase resistance above that of the conductor.
6. No external power or heat is required to make connections.
7. Quality can be assessed visually.
8. Easy and simple to install.

USEFUL INFORMATION

Exothermic welding process

The exothermic welding process is a method of making electrical connections of copper to copper or copper to steel in which no outside source of heat or power is required.

In this process, granular metals (granular copper oxide and aluminium) are placed from a container into a graphite crucible and ignited.

The reduction of copper oxide by the aluminium (exothermic reaction) produces molten copper and aluminium oxide slag.

The slag floats to the surface and the disk melts, allowing molten copper to flow into the weld cavity and complete the weld. The weld is allowed to solidify. The mold is removed and made ready for the next weld. The process takes seconds to complete.

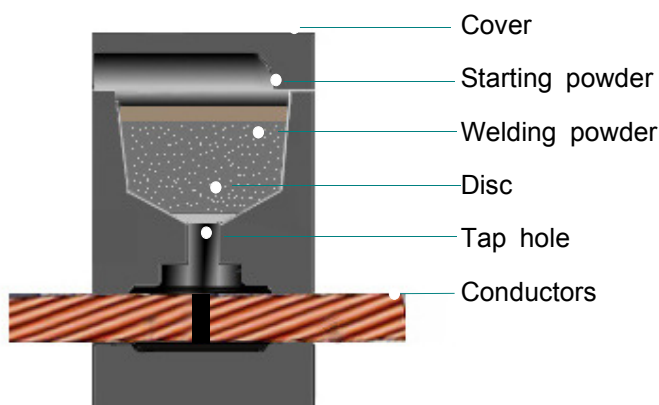

This brochure shows standard type of connections. Use the index and check the type of connection required. If a suitable mold is not listed for your required application, contact Korea EMI Technologies co.,Ltd. for the availability of non standard type molds.

1. Check the type of connection.
2. Check the sizes of conductors to be welded.
3. Check tools and parts required for welding.

Test Certificate, Registrations & STD complied.

- ISO9001
- IEEE-Std-837-2002 (EM & Fault Current)
- IEEE-Std-80-2000
- ASTM E8-94A (Tensile Strength)
- Trade Mark (EXOWELD)
- Temperature Test
- Chemical composition
- MSDS
- MPE test

Standard of Copper conductors

Cross Section (mmsq)	Diameter (mm)	Composition N / mmΦ
6	3.12	7/1.04
10	4.05	7/1.35
16	5.10	7/1.70
25	6.42 6.75	7/2.14 19/1.35
35	7.56 7.65	7/2.52 19/1.53
50	8.9	19/1.78
70	10.7	19/2.14
95	12.46 12.6	37/1.78 19/2.52
120	14.21	37/2.03
150	15.75	37/2.25
185	17.64	37/2.52
240	20.25	61/2.25
300	22.68	61/2.52
400	25.69 25.96	61/2.85 91/2.35
500	28.8 29.15	61/3.2 91/2.65

General tools

- Flint Ignitor
- Mold brush
- Slag removal spade
- Cable brush
- Gas torch
- Vise Grip plier

Typical Connections

Cable / Cable

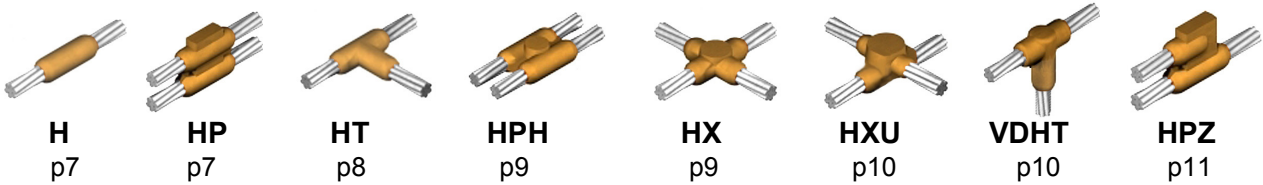

Cable / Earth Rod

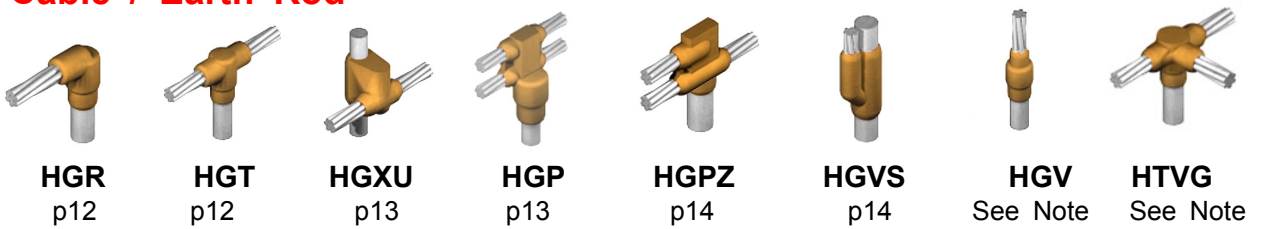

Cable / Steel Surface

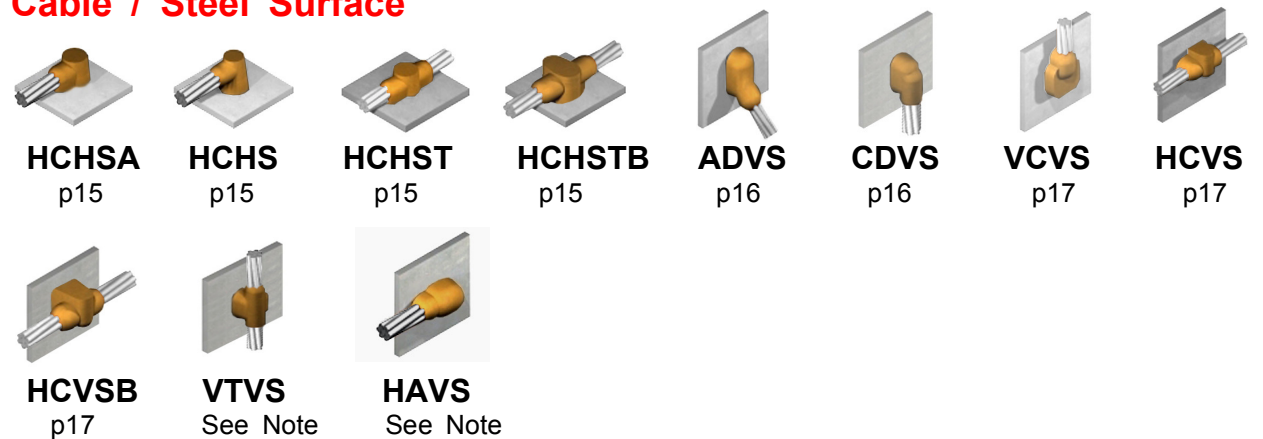

Cable / Busbar or Terminal Lug

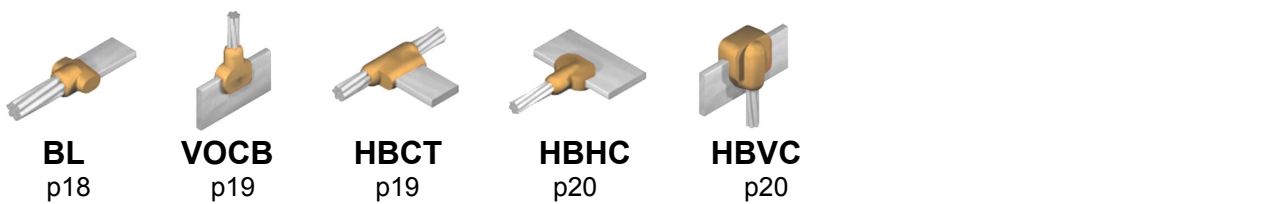

Busbar / Busbar

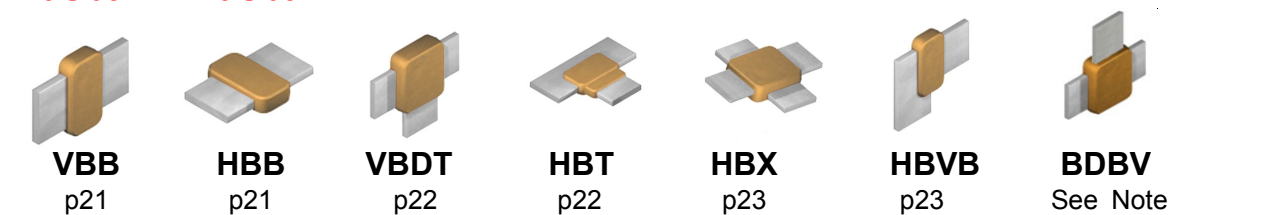

Note : Contact EXOWELD® for information on these and other types of weld not listed.

Typical Connections

Bus Bar / Earth Rod or Steel Surface

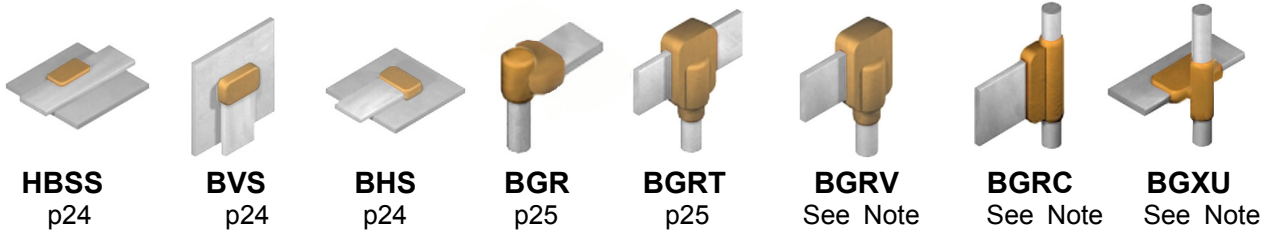

Rebar / Cable or Busbar

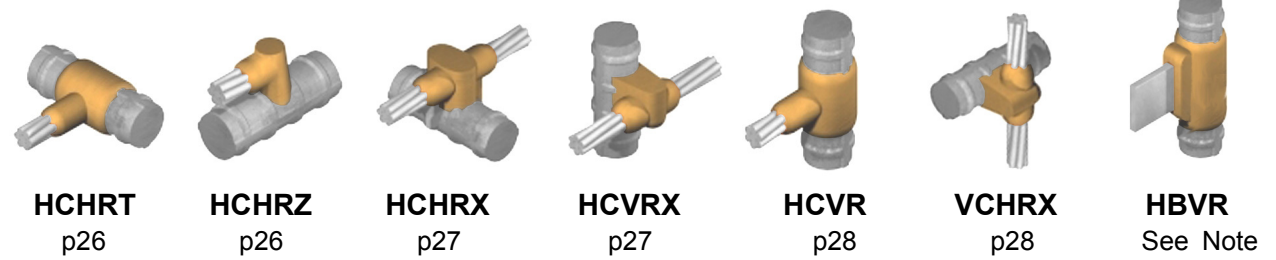

Cable / Earth Plate

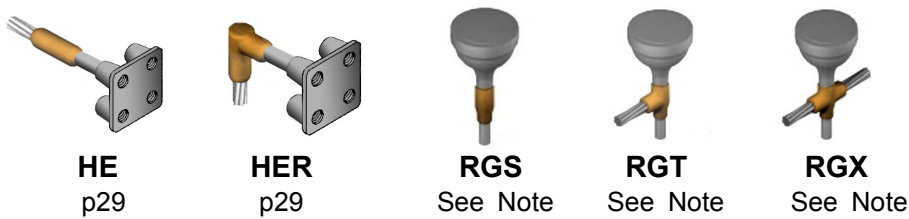

For Cathodic connections

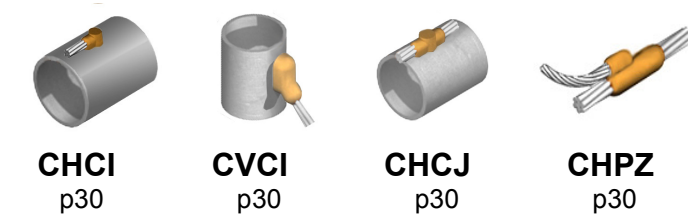

Cable / Railway



Note : Contact EXOWELD® for information on these and other types of weld not listed.

TOOLS AND ACCESSORIES

Exothermic weld metal is a mixture of copper oxide and aluminum, packaged by size in a plastic cartridge. The starting powder is packed in the red coloured small plastic tube separately to avoid mixing with weld metal while transportation. These cartridges are packaged in boxes along with metal disks and starting powder tubes. Each weld requires one disk and one starting powder.

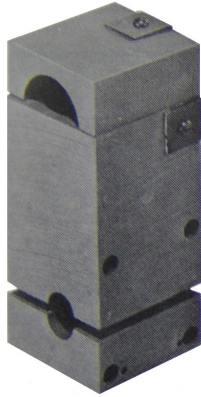

Molds

A graphite mold is used for exothermic welding connections. The mold controls the direction and speed of the molten weld metal flow and the formation of the weld.

The graphite used is a high temperature type that lasts for an average of 50 or more welding connections under normal usage.



Handle Clamps

such as the one shown above are required for most molds. Two types of Handle Clamps are available.

1. EC-M for all molds 3" wide.
2. EC-L for all molds 4" wide.

For some molds, specialized frames with handles are required.

Flint Ignitors EF-R & EF-RH

Flint Ignitors are used to ignite the starting material.

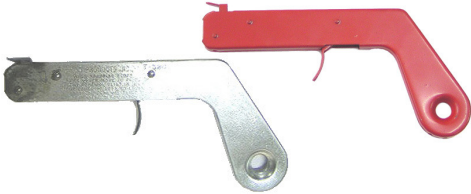

Slag Removal Spade ET-009

is useful for removing the slag from the mold after the welding connection is completed. They are especially useful for horizontally split molds.

Cable Cleaning Brush ET-008-1

V-Shaped Brush cleans any conductor and is especially useful for coarse or very dirty conductors.

The brushes can be rotated to provide new cleaning bristles and are replaceable.

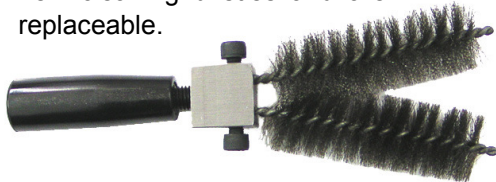

Mold brush EB-R

is useful for removing the slag from the mold after the welding connection is completed.



Cable Brush ET-008 is recommended for cleaning heavily oxidized conductors and surfaces prior to the welding connection.



Disks are used to seal the tap hole.
 19mm Dia. disk : for #15 thru #65
 26mm Dia. disk : for #90 & #115
 38mm Dia. disk : for #150 or larger



Mold Sealer ES-M is for sealing molds to eliminate leakage of molten weld metal.

Cable to Cable

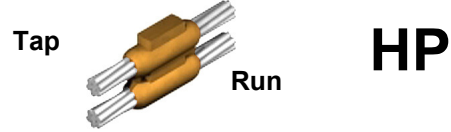
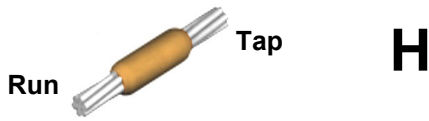

A(Run)	B(Tap)	Mold Code	Weld Metal	Price Key	Handle Clamp
10 mm2	10mm2	H1010	32	M	EC-M
16	16	H1616	32	M	EC-M
25	25	H2525	32	M	EC-M
30	30	H3030	32	M	EC-M
35	35	H3535	32	M	EC-M
50	50	H5050	45	M	EC-M
50	70	H5070	65	M	EC-M
50	95	H5095	90	M	EC-M
70	70	H7070	65	M	EC-M
70	95	H7095	90	M	EC-M
70	120	H70120	115	M	EC-M
95	95	H9595	90	M	EC-M
95	120	H95120	115	M	EC-M
120	120	H120120	115	M	EC-M
150	150	H150150	115	M	EC-M
185	185	H185185	150	H	EC-M
240	240	H240240	200	H	EC-M
300	300	H300300	250	H	EC-M
400	400	H400400	2 X 150	J	EC-L
500	500	H500500	2 X 200	J	EC-L

A(Run)	B(Tap)	Mold Code	Weld Metal	Price Key	Handle Clamp
10mm2	10mm2	HP1010	45	M	EC-M
16	16	HP1616	45	M	EC-M
25	25	HP2525	45	M	EC-M
30	30	HP3030	45	M	EC-M
35	25	HP3525	65	M	EC-M
35	30	HP3530	65	M	EC-M
35	35	HP3535	65	M	EC-M
50	25	HP5025	65	M	EC-M
50	35	HP5035	90	M	EC-M
50	50	HP5050	90	M	EC-M
70	30	HP7030	90	M	EC-M
70	35	HP7035	90	M	EC-M
70	50	HP7050	115	H	EC-M
70	70	HP7070	115	H	EC-M
95	25	HP9525	115	H	EC-M
95	35	HP9535	115	H	EC-M
95	50	HP9550	115	H	EC-M
95	70	HP9570	150	H	EC-M
95	95	HP9595	150	H	EC-M
120	50	HP12050	150	H	EC-M
120	70	HP12070	150	H	EC-M
120	95	HP12095	200	H	EC-M
120	120	HP120120	200	H	EC-M
150	70	HP15070	150	H	EC-M
150	95	HP15095	200	H	EC-M
150	120	HP150120	250	H	EC-M
150	150	HP150150	2 X 150	J	EC-L
185	95	HP18595	200	H	EC-M
185	120	HP185120	250	H	EC-M
185	150	HP185150	2 X 150	J	EC-L
185	185	HP185185	2 X 150	J	EC-L
240	120	HP240120	250	H	EC-M
240	150	HP240150	2 X 150	J	EC-L
240	185	HP240185	2 X 150	J	EC-L
240	240	HP240240	2 X 200	J	EC-L
300	150	HP300150	2 X 150	J	EC-L
300	185	HP300185	2 X 200	J	EC-L
300	240	HP300240	2 X 250	L+	EC-L
300	300	HP300300	2 X 250	L+	EC-L

Place the cables into position in the mold with cable ends butting together under the center of the tap hole.

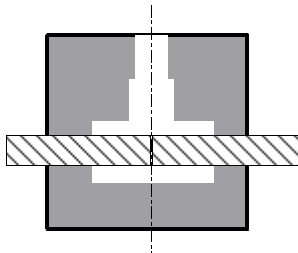

Do not cut either cable unless specifically required. If the top cable is cut or is required to be cut be sure when placing the cables into position in the mold that the top cables are centered under the tap hole.

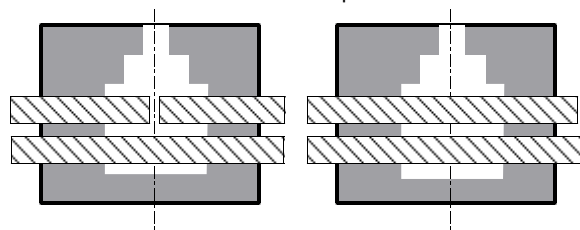

Cable to Cable

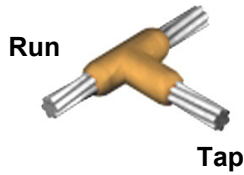

HT

A(Run)	B(Tap)	Mold Code	Weld Metal	Price Key	Handle Clamp
10 mm2	10mm2	HT1010	32	M	EC-M
16	16	HT1616	45	M	EC-M
25	10	HT2510	45	M	EC-M
25	16	HT2516	45	M	EC-M
25	25	HT2525	45	M	EC-M
30	16	HT3016	45	M	EC-M
30	25	HT3025	45	M	EC-M
30	30	HT3030	45	M	EC-M
35	16	HT3516	45	M	EC-M
35	25	HT3025	45	M	EC-M
35	30	HT3530	45	M	EC-M
35	35	HT3535	45	M	EC-M
50	16	HT5016	45	M	EC-M
50	25	HT5025	45	M	EC-M
50	35	HT5035	45	M	EC-M
50	50	HT5050	90	M	EC-M
70	6	HT706	45	M	EC-M
70	16	HT7016	65	M	EC-M
70	25	HT7025	65	M	EC-M
70	30	HT7030	65	M	EC-M
70	35	HT7035	65	M	EC-M
70	50	HT7050	90	M	EC-M
70	70	HT7070	90	M	EC-M
70	120	HT70120	115	M	EC-M
70	150	HT70150	115	M	EC-M
95	16	HT9516	90	M	EC-M
95	25	HT9525	90	M	EC-M
95	30	HT9530	90	M	EC-M
95	35	HT9535	90	M	EC-M
95	50	HT9550	90	M	EC-M
95	70	HT9570	90	M	EC-M
95	95	HT9595	115	M	EC-M
120	16	HT12016	90	M	EC-M
120	25	HT12025	90	M	EC-M
120	30	HT12030	90	M	EC-M
120	35	HT12035	90	M	EC-M
120	50	HT12050	90	M	EC-M
120	70	HT12070	90	M	EC-M
120	95	HT12095	150	H	EC-M
120	120	HT120120	150	H	EC-M
120	300	HT120300	200	H	EC-M
150	16	HT15016	90	M	EC-M
150	25	HT15025	90	M	EC-M
150	30	HT15030	90	M	EC-M
150	35	HT15035	90	M	EC-M
150	50	HT15050	90	M	EC-M
150	70	HT15070	90	M	EC-M
150	95	HT15095	150	H	EC-M
150	120	HT150120	150	H	EC-M
150	150	HT150150	200	H	EC-M

A(Run)	B(Tap)	Mold Code	Weld Metal	Price Key	Handle Clamp
185	16	HT18516	90	M	EC-M
185	25	HT18525	90	M	EC-M
185	35	HT18535	90	M	EC-M
185	50	HT18550	115	M	EC-M
185	70	HT18570	115	M	EC-M
185	95	HT18595	150	H	EC-M
185	120	HT185120	200	H	EC-M
185	150	HT185150	200	H	EC-M
185	185	HT185185	200	H	EC-M
185	315R	HT185315R	2 X 150	R	EC-M
240	16	HT24016	90	M	EC-M
240	25	HT24025	90	M	EC-M
240	35	HT24035	90	M	EC-M
240	50	HT24050	90	M	EC-M
240	70	HT24070	115	M	EC-M
240	95	HT24095	200	H	EC-M
240	120	HT240120	200	H	EC-M
240	150	HT240150	200	H	EC-M
240	185	HT240185	200	H	EC-M
240	240	HT240240	2 X 150	R	EC-M
240	400	HT240400	2 X 200	L+	EC-L
240	500	HT240500	2 X 200	L+	EC-L
300	16	HT30016	90	M	EC-M
300	25	HT30025	115	M	EC-M
300	35	HT30035	115	M	EC-M
300	50	HT30050	115	M	EC-M
300	70	HT30070	200	H	EC-M
300	95	HT30095	200	H	EC-M
300	120	HT300120	200	H	EC-M
300	150	HT300150	200	H	EC-M
300	185	HT300185	250	H	EC-M
300	240	HT300240	2 X 200	L+	EC-L
300	300	HT300300	2 X 200	L+	EC-L
400	95	HT40095	250	H	EC-M
400	185	HT400185	2 X 150	R	EC-M
400	300	HT400300	2 X 200	L+	EC-L
400	400	HT400400	2 X 250	L+	EC-L
500	500	HT500500	2 X 250	L+	EC-L

Place the cables into position in the mold with the tap cable butting against the run cable.

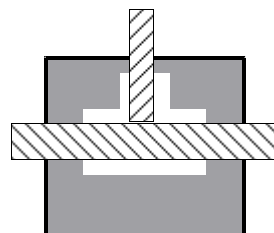

Cable to Cable

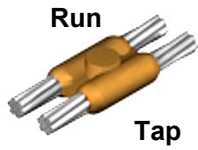

HPH

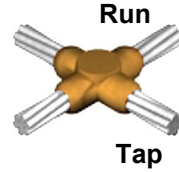

HX

A(Run)	B(Tap)	Mold Code	Weld Metal	Price Key	Handle Clamp
10mm2	10mm2	HPH1010	45	M	EC-M
16	16	HPH1616	45	M	EC-M
25	25	HPH2525	45	M	EC-M
30	30	HPH3030	65	M	EC-M
35	25	HPH3525	65	M	EC-M
35	35	HPH3535	65	M	EC-M
50	25	HPH5025	90	M	EC-M
50	35	HPH5035	90	M	EC-M
50	50	HPH5050	90	M	EC-M
70	25	HPH7025	90	M	EC-M
70	35	HPH7035	90	M	EC-M
70	50	HPH7050	115	M	EC-M
70	70	HPH7070	115	M	EC-M
95	35	HPH9535	115	M	EC-M
95	50	HPH9550	150	H	EC-M
95	70	HPH9570	150	H	EC-M
95	95	HPH9595	150	H	EC-M
120	50	HPH12050	150	H	EC-M
120	70	HPH12070	200	H	EC-M
120	95	HPH12095	200	H	EC-M
120	120	HPH120120	200	H	EC-M
150	70	HPH15070	150	H	EC-M
150	95	HPH15095	200	H	EC-M
150	120	HPH150120	250	H	EC-M
150	150	HPH150150	250	H	EC-M
185	120	HPH185120	250	H	EC-M
185	150	HPH185150	250	H	EC-M
185	185	HPH185185	2 X 150	R	EC-M
240	185	HPH240185	2 X 200	L+	EC-L
240	240	HPH240240	2 X 250	L+	EC-L

A(Run)	B(Tap)	Mold Code	Weld Metal	Price Key	Handle Clamp
10 mm2	10mm2	HX1010	45	M	EC-M
16	16	HX1616	45	M	EC-M
25	25	HX2525	45	M	EC-M
30	30	HX3030	65	M	EC-M
35	25	HX3525	65	M	EC-M
35	35	HX3535	65	M	EC-M
50	25	HX5025	90	M	EC-M
50	35	HX5035	90	M	EC-M
50	50	HX5050	90	M	EC-M
70	25	HX7025	115	M	EC-M
70	35	HX7035	115	M	EC-M
70	50	HX7050	115	M	EC-M
70	70	HX7070	115	M	EC-M
95	35	HX9535	115	M	EC-M
95	50	HX9550	115	M	EC-M
95	70	HX9570	150	H	EC-M
95	95	HX9595	150	H	EC-M
120	25	HX12025	150	H	EC-M
120	35	HX12035	150	H	EC-M
120	50	HX12050	150	H	EC-M
120	70	HX12070	150	H	EC-M
120	95	HX12095	200	H	EC-M
120	120	HX120120	200	H	EC-M
150	50	HX15050	150	H	EC-M
150	70	HX15070	150	H	EC-M
150	95	HX15095	200	H	EC-M
150	120	HX150120	250	H	EC-M
150	150	HX150150	250	H	EC-M
185	50	HX18550	200	H	EC-M
185	70	HX18570	200	H	EC-M
185	95	HX18595	200	H	EC-M
185	120	HX185120	250	H	EC-M
185	150	HX185150	250	H	EC-M
185	185	HX185185	2 X 150	R	EC-M
240	95	HX24095	250	H	EC-M
240	120	HX240120	2 X 150	R	EC-M
240	150	HX240150	2 X 200	L+	EC-L
240	185	HX240185	2 X 200	L+	EC-L
240	240	HX240240	2 X 250	L+	EC-L
300	120	HX300120	2 X 150	R	EC-M
300	300	HX300300	2 X 250	L+	EC-L
400	400	HX400400	4 X 200	L+	EC-L
500	500	HX500500	4 X 200	L+	EC-L

Do not cut either cable unless specifically required. Place cables into position in the mold.

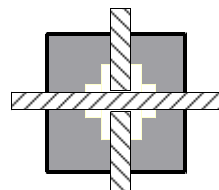
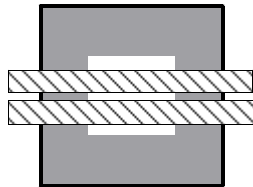

The larger cable should be cut and the smaller cable placed into position so that it butts up against the larger cable.

Cable to Cable

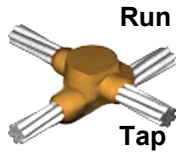

HXU

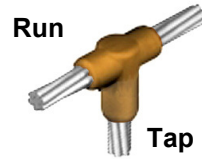

VDHT

A(Run)	B(Tap)	Mold Code	Weld Metal	Price Key	Handle Clamp
10 mm2	10mm2	HXU1010	65	J	EC-M
16	16	HXU1616	65	J	EC-M
25	25	HXU2525	65	J	EC-M
30	30	HXU3030	90	J	EC-M
35	25	HXU3525	90	J	EC-M
35	35	HXU3535	90	J	EC-M
50	25	HXU5025	115	J	EC-M
50	35	HXU5035	150	J	EC-M
50	50	HXU5050	150	J	EC-M
70	25	HXU7025	150	J	EC-M
70	35	HXU7035	150	J	EC-M
70	50	HXU7050	200	J	EC-M
70	70	HXU7070	200	J	EC-M
95	35	HXU9535	200	J	EC-M
95	50	HXU9550	200	J	EC-M
95	70	HXU9570	250	J	EC-M
95	95	HXU9595	250	J	EC-M
120	25	HXU12025	200	J	EC-M
120	35	HXU12035	200	J	EC-M
120	50	HXU12050	250	J	EC-M
120	70	HXU12070	250	J	EC-M
120	95	HXU12095	2 X 150	Y	EC-L
120	120	HXU120120	2 X 150	Y	EC-L
150	50	HXU15050	250	J	EC-M
150	70	HXU15070	2 X 150	Y	EC-L
150	95	HXU15095	2 X 150	Y	EC-L
150	120	HXU150120	2 X 200	Y	EC-L
150	150	HXU150150	2 X 200	Y	EC-L
185	70	HXU18570	2 X 150	Y	EC-L
185	95	HXU18595	2 X 200	Y	EC-L
185	120	HXU185120	2 X 250	Y	EC-L
185	150	HXU185150	2 X 250	Y	EC-L
185	185	HXU185185	2 X 250	Y	EC-L
240	95	HXU24095	2 X 250	Y	EC-L
240	120	HXU240120	2 X 250	Y	EC-L
240	150	HXU240150	3 X 200	Y	EC-L
240	185	HXU240185	3 X 200	Y	EC-L
240	240	HXU240240	3 X 250	Y	EC-L
300	300	HXU300300	3 X 250	Y	EC-L
400	400	HXU400400	5 X 250	S	EC-L

A(Run)	B(Tap)	Mold Code	Weld Metal	Price Key	Handle Clamp
10	10	VDHT1010	32	M	EC-M
16	16	VDHT1616	32	M	EC-M
25	25	VDHT2525	32	M	EC-M
35	25	VDHT3525	45	M	EC-M
35	35	VDHT3535	45	M	EC-M
50	35	VDHT5035	90	H	EC-M
50	50	VDHT5050	90	H	EC-M
70	35	VDHT7035	90	H	EC-M
70	50	VDHT7050	115	H	EC-M
70	70	VDHT7070	115	H	EC-M
95	50	VDHT9550	150	H	EC-M
95	70	VDHT9570	150	H	EC-M
95	95	VDHT9595	150	H	EC-M
120	70	VDHT12070	150	H	EC-M
120	95	VDHT12095	150	H	EC-M
120	120	VDHT120120	150	H	EC-M
150	70	VDHT15070	200	H	EC-M
150	95	VDHT15095	200	H	EC-M
150	120	VDHT150120	200	H	EC-M
150	150	VDHT150150	200	H	EC-M
185	95	VDHT18595	200	H	EC-M
185	120	VDHT185120	200	H	EC-M
185	150	VDHT185150	200	H	EC-M
185	185	VDHT185185	250	H	EC-M
240	120	VDHT240120	250	H	EC-M
240	150	VDHT240150	250	H	EC-M
240	185	VDHT240185	2 X 150	J	EC-L
240	240	VDHT240240	2 X 150	J	EC-L

Cable can be spliced with 3mm gap under the center of the tap hole.

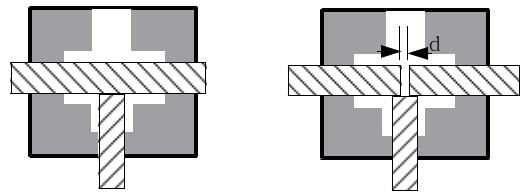

Smaller size cable to be placed over the larger one.

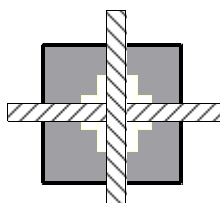

Cable to Cable

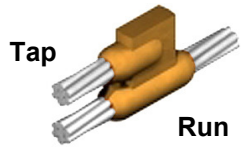

HPZ

A(Run)	B(Tap)	Mold Code	Weld Metal	Price Key	Handle Clamp
10mm2	10mm2	HPZ1010	32	M	EC-M
16	16	HPZ1616	32	M	EC-M
25	25	HPZ2525	32	M	EC-M
30	30	HPZ3030	65	M	EC-M
35	25	HPZ3525	45	M	EC-M
35	35	HPZ3535	65	M	EC-M
50	25	HPZ5025	65	M	EC-M
50	35	HPZ5035	65	M	EC-M
50	50	HPZ5050	90	H	EC-M
70	25	HPZ7025	90	H	EC-M
70	35	HPZ7035	90	H	EC-M
70	50	HPZ7050	115	H	EC-M
70	70	HPZ7070	115	H	EC-M
95	25	HPZ9525	115	H	EC-M
95	35	HPZ9535	115	H	EC-M
95	50	HPZ9550	115	H	EC-M
95	70	HPZ9570	150	H	EC-M
95	95	HPZ9595	150	H	EC-M
120	35	HPZ12035	115	H	EC-M
120	50	HPZ12050	115	H	EC-M
120	70	HPZ12070	150	H	EC-M
120	95	HPZ12095	200	H	EC-M
120	120	HPZ120120	200	H	EC-M
150	70	HPZ15070	150	H	EC-M
150	95	HPZ15095	200	H	EC-M
150	120	HPZ150120	250	H	EC-M
150	150	HPZ150150	250	H	EC-M
185	95	HPZ18595	150	H	EC-M
185	120	HPZ185120	200	H	EC-M
185	150	HPZ185150	250	H	EC-M
185	185	HPZ185185	250	H	EC-M
240	120	HPZ240120	200	H	EC-M
240	150	HPZ240150	250	H	EC-M
240	185	HPZ240185	250	H	EC-M
240	240	HPZ240240	2 X 150	J	EC-L

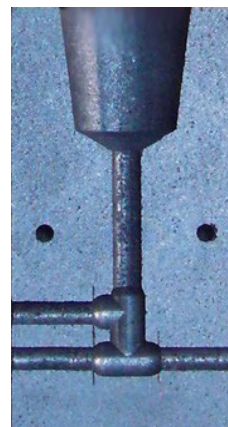

Do not cut run cable.
Place tap cable end under the center of the tap hole.

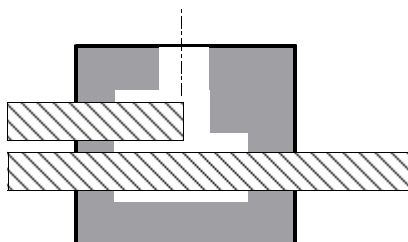

Cable to Rod

Tap

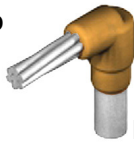

HGR

Run

Tap

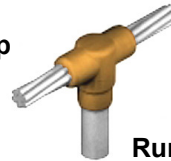

HGT

Run

A(Run)	B(Tap)	Mold Code	Weld Metal	Price Key	Handle Clamp
	25	HGR1125	65	H	EC-M
	35	HGR1135	65	H	EC-M
[11.1mm]	50	HGR1150	65	H	EC-M
	70	HGR1170	90	H	EC-M
	95	HGR1195	90	H	EC-M
	120	HGR11120	90	H	EC-M
	150	HGR11150	90	H	EC-M
	16	HGR1216	45	H	EC-M
	25	HGR1225	65	H	EC-M
	30	HGR1230	65	H	EC-M
1/2 inch	35	HGR1235	65	H	EC-M
[12.7mm]	50	HGR1250	65	H	EC-M
	70	HGR1270	90	H	EC-M
	95	HGR1295	90	H	EC-M
	120	HGR12120	90	H	EC-M
	150	HGR12150	115	H	EC-M
	185	HGR12185	115	H	EC-M
	16	HGR1416	65	H	EC-M
	25	HGR1425	65	H	EC-M
	30	HGR1430	65	H	EC-M
	35	HGR1435	90	H	EC-M
5/8 inch	50	HGR1450	90	H	EC-M
[14.2mm]	70	HGR1470	90	H	EC-M
	95	HGR1495	90	H	EC-M
	120	HGR14120	90	H	EC-M
	150	HGR14150	115	H	EC-M
	185	HGR14185	150	H	EC-M
	240	HGR14240	150	H	EC-M
	25	HGR1725	65	H	EC-M
	30	HGR1730	90	H	EC-M
	35	HGR1735	90	H	EC-M
	50	HGR1750	90	H	EC-M
3/4 inch	70	HGR1770	90	H	EC-M
[17.2mm]	95	HGR1795	90	H	EC-M
	120	HGR17120	90	H	EC-M
	150	HGR17150	115	H	EC-M
	185	HGR17185	150	H	EC-M
	240	HGR17240	150	H	EC-M
	300	HGR17300	200	H	EC-M

A(Run)	B(Tap)	Mold Code	Weld Metal	Price Key	Handle Clamp
	25	HGT1125	90	H	EC-M
	35	HGT1135	90	H	EC-M
[11.1mm]	50	HGT1150	90	H	EC-M
	70	HGT1170	90	H	EC-M
	95	HGT1195	115	H	EC-M
	120	HGT11120	150	H	EC-M
	150	HGT11150	150	H	EC-M
	16	HGT1216	90	H	EC-M
	25	HGT1225	90	H	EC-M
	30	HGT1230	90	H	EC-M
1/2 inch	35	HGT1235	90	H	EC-M
[12.7mm]	50	HGT1250	90	H	EC-M
	70	HGT1270	90	H	EC-M
	95	HGT1295	115	H	EC-M
	120	HGT12120	150	H	EC-M
	150	HGT12150	150	H	EC-M
	185	HGT12185	200	H	EC-M
	16	HGT1416	90	H	EC-M
	25	HGT1425	90	H	EC-M
	30	HGT1430	90	H	EC-M
	35	HGT1435	90	H	EC-M
5/8 inch	50	HGT1450	90	H	EC-M
[14.2mm]	70	HGT1470	115	H	EC-M
	95	HGT1495	115	H	EC-M
	120	HGT14120	150	H	EC-M
	150	HGT14150	200	H	EC-M
	185	HGT14185	200	H	EC-M
	240	HGT14240	250	H	EC-M
	25	HGT1725	90	H	EC-M
	30	HGT1730	90	H	EC-M
	35	HGT1735	90	H	EC-M
	50	HGT1750	115	H	EC-M
3/4 inch	70	HGT1770	115	H	EC-M
[17.2mm]	95	HGT1795	115	H	EC-M
	120	HGT17120	150	H	EC-M
	150	HGT17150	200	H	EC-M
	185	HGT17185	200	H	EC-M
	240	HGT17240	250	H	EC-M
	300	HGT17300	2 X 150	R	EC-M

Place the rod and cable into position in the mold. The cable end should sit on top of the rod and be positioned 3mm short of the center of the tap hole.

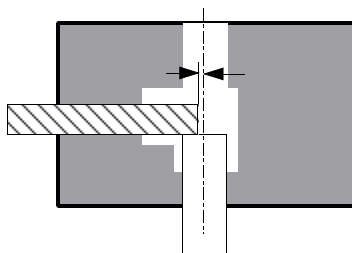

Place the rod and cables into position in the mold. The cable should be positioned on top of the rod and can be spliced with 3mm gap under the center of the tap hole.

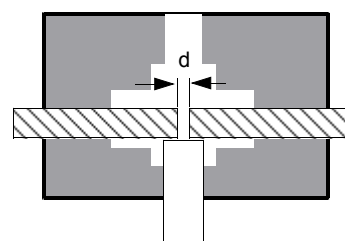

Cable to Rod

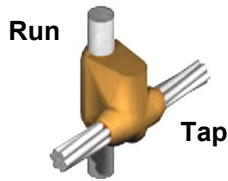

HGXU

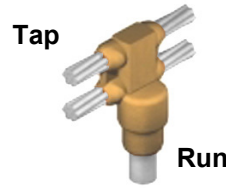

HGP

A(Run)	B(Tap)	Mold Code	Weld Metal	Price Key	Handle Clamp
	25	HGXU1125	90	M+	EC-M
	35	HGXU1135	90	M+	EC-M
[11.1mm]	50	HGXU1150	115	M+	EC-M
	70	HGXU1170	115	M+	EC-M
	95	HGXU1195	115	M+	EC-M
	120	HGXU11120	150	M+	EC-M
	150	HGXU11150	200	M+	EC-M
	16	HGXU1216	90	M+	EC-M
	25	HGXU1225	90	M+	EC-M
	30	HGXU1230	90	M+	EC-M
1/2 inch	35	HGXU1235	90	M+	EC-M
[12.7mm]	50	HGXU1250	115	M+	EC-M
	70	HGXU1270	115	M+	EC-M
	95	HGXU1295	115	M+	EC-M
	120	HGXU12120	150	M+	EC-M
	150	HGXU12150	200	M+	EC-M
	185	HGXU12185	200	M+	EC-M
	16	HGXU1416	90	M+	EC-M
	25	HGXU1425	90	M+	EC-M
	30	HGXU1430	90	M+	EC-M
	35	HGXU1435	90	M+	EC-M
5/8 inch	50	HGXU1450	115	M+	EC-M
[14.2mm]	70	HGXU1470	115	M+	EC-M
	95	HGXU1495	115	M+	EC-M
	120	HGXU14120	150	M+	EC-M
	150	HGXU14150	200	M+	EC-M
	185	HGXU14185	250	M+	EC-M
	240	HGXU14240	2 X 200	S	EC-L
	25	HGXU1725	90	M+	EC-M
	30	HGXU1730	90	M+	EC-M
	35	HGXU1735	90	M+	EC-M
	50	HGXU1750	115	M+	EC-M
3/4 inch	70	HGXU1770	150	M+	EC-M
[17.2mm]	95	HGXU1795	150	M+	EC-M
	120	HGXU17120	200	M+	EC-M
	150	HGXU17150	250	M+	EC-M
	185	HGXU17185	2 X 200	S	EC-L
	240	HGXU17240	2 X 250	S	EC-L
	300	HGXU17300	3 X 200	S	EC-L

Place the rod and cable into position in the mold. Secure the back plate into position so that it encloses the rod. The mold should be supported with vice grip pliers or via a clamp on the rod.

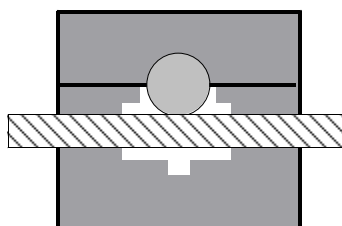

A(Run)	B(Tap)	Mold Code	Weld Metal	Price Key	Handle Clamp
	25	HGP1125	115	H	EC-M
	30	HGP1130	115	H	EC-M
	35	HGP1135	115	H	EC-M
[11.1mm]	50	HGP1150	150	H	EC-M
	70	HGP1170	250	H	EC-M
	95	HGP1195	250	H	EC-M
	120	HGP11120	2 X 150	J	EC-L
	150	HGP11150	2 X 200	L+	EC-L
	16	HGP1216	90	H	EC-M
	25	HGP1225	115	H	EC-M
	30	HGP1230	115	H	EC-M
1/2 inch	35	HGP1235	115	H	EC-M
[12.7mm]	50	HGP1250	150	H	EC-M
	70	HGP1270	200	H	EC-M
	95	HGP1295	250	H	EC-M
	120	HGP12120	2 X 150	J	EC-L
	150	HGP12150	2 X 200	J	EC-L
	16	HGP1416	90	H	EC-M
	25	HGP1425	115	H	EC-M
	30	HGP1430	150	H	EC-M
	35	HGP1435	150	H	EC-M
5/8 inch	50	HGP1450	200	H	EC-M
[14.2mm]	70	HGP1470	250	H	EC-M
	95	HGP1495	2 X 150	J	EC-L
	120	HGP14120	2 X 200	J	EC-L
	150	HGP14150	3 X 150	L+	EC-L
	185	HGP14185	2 X 250	L+	EC-L
	240	HGP14240	3 X 250	L+	EC-L
	25	HGP1725	115	H	EC-M
	30	HGP1730	150	H	EC-M
	35	HGP1735	150	H	EC-M
	50	HGP1750	200	H	EC-M
3/4 inch	70	HGP1770	250	H	EC-M
[17.2mm]	95	HGP1795	2 X 150	J	EC-L
	120	HGP17120	2 X 200	J	EC-L
	150	HGP17150	3 X 150	L+	EC-L
	185	HGP17185	3 X 200	L+	EC-L
	240	HGP17240	3 X 250	L+	EC-L
	300	HGP17300	3 X 250	L+	EC-L

Place the rod and cables into position in the mold. The top cable should be placed on top of the rod and be spliced with a 3mm gap under the center of the tap hole.

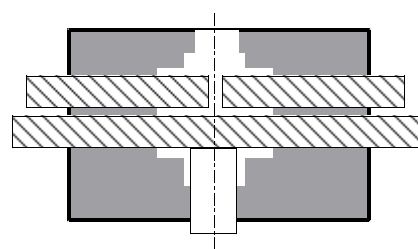

Cable to Rod

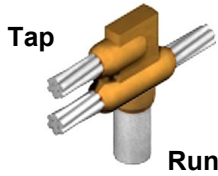

HGPZ

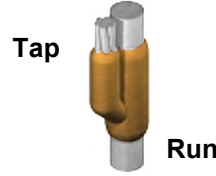

HGVS

A(Run)	B(Tap)	Mold Code	Weld Metal	Price Key	Handle Clamp
	16mm2	HGPZ1216	90	H	EC-M
	25	HGPZ1225	90	H	EC-M
	30	HGPZ1230	90	H	EC-M
1/2 inch	35	HGPZ1235	115	H	EC-M
[12.7mm]	50	HGPZ1250	115	H	EC-M
	70	HGPZ1270	150	H	EC-M
	95	HGPZ1295	200	H	EC-M
	16	HGPZ1416	90	H	EC-M
	25	HGPZ1425	90	H	EC-M
	30	HGPZ1430	115	H	EC-M
	35	HGPZ1435	115	H	EC-M
5/8 inch	50	HGPZ1450	150	H	EC-M
[14.2mm]	70	HGPZ1470	200	H	EC-M
	95	HGPZ1495	250	H	EC-M
	120	HGPZ14120	2 X 150	J	EC-L
	150	HGPZ14150	2 X 200	J	EC-L
	185	HGPZ14185	2 X 150	J	EC-L
	240	HGPZ14240	3 X 200	L+	EC-L
	25	HGPZ1725	115	H	EC-M
	30	HGPZ1730	115	H	EC-M
	35	HGPZ1735	150	H	EC-M
	50	HGPZ1750	150	H	EC-M
3/4 inch	70	HGPZ1770	200	H	EC-M
[17.2mm]	95	HGPZ1795	250	H	EC-M
	120	HGPZ17120	2 X 150	J	EC-L
	150	HGPZ17150	2 X 200	J	EC-L
	185	HGPZ17185	3 X 150	L+	EC-L
	240	HGPZ17240	3 X 200	L+	EC-L
	25	HGPZ2525	115	H	EC-M
	30	HGPZ2530	150	H	EC-M
	35	HGPZ2535	150	H	EC-M
	50	HGPZ2550	200	H	EC-M
1 inch	70	HGPZ2570	250	H	EC-M
[25.4mm]	95	HGPZ2595	2 X 150	J	EC-L
	120	HGPZ25120	2 X 200	J	EC-L
	150	HGPZ25150	3 X 150	L+	EC-L
	185	HGPZ25185	3 X 200	L+	EC-L
	240	HGPZ25240	3 X 250	L+	EC-L

Place the rod and cables into position in the mold. The top cable should be placed on top of the rod and be spliced with a 3mm gap under the center of the tap hole.

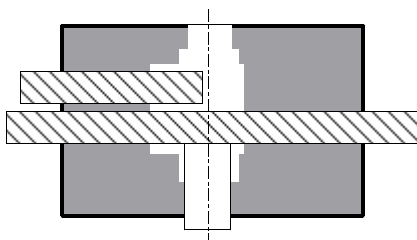

A(Run)	B(Tap)	Mold Code	Weld Metal	Price Key	Handle Clamp
	25	HGVS1225	90	J	EC-M
	35	HGVS1235	90	J	EC-M
1/2 inch	50	HGVS1250	90	J	EC-M
[12.7mm]	70	HGVS1270	90	J	EC-M
	95	HGVS1295	115	J	EC-M
	120	HGVS12120	150	J	EC-M
	150	HGVS12150	150	J	EC-M
	185	HGVS12185	200	J	EC-M
	25	HGVS1425	90	J	EC-M
	35	HGVS1435	90	J	EC-M
	50	HGVS1450	90	J	EC-M
	70	HGVS1470	115	J	EC-M
5/8 inch	95	HGVS1495	115	J	EC-M
[14.2mm]	120	HGVS14120	150	J	EC-M
	150	HGVS14150	200	J	EC-M
	185	HGVS14185	200	J	EC-M
	240	HGVS14240	250	M+	EC-M
	25	HGVS1725	90	J	EC-M
	35	HGVS1735	90	J	EC-M
	50	HGVS1750	115	J	EC-M
3/4 inch	70	HGVS1770	115	J	EC-M
[17.2mm]	95	HGVS1795	115	J	EC-M
	120	HGVS17120	150	J	EC-M
	150	HGVS17150	200	J	EC-M
	185	HGVS17185	200	J	EC-M
	240	HGVS17240	250	M+	EC-M

Place the rod and cable into position in the mold. The mold should be supported with vice grip pliers or via a clamp on the rod.

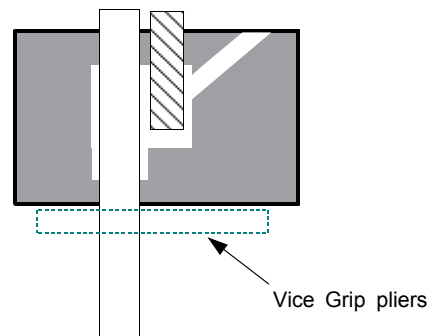

Cable to Flat/Round

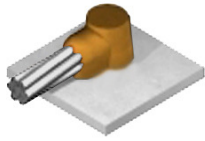

HCHSA

Cable	Mold Code	Weld Metal	Price Key	Handle Clamp
16	HCHSA16	45	F2	FF
25	HCHSA25	45	F2	FF
35	HCHSA35	45	F2	FF
50	HCHSA50	45	F2	FF
70	HCHSA70	65	F2	FF

Cable on surface.
 Cable to pipe - Use Mold code with suffix for 12" and smaller pipe.

Example : 50 cable to 4 1/2 " pipe.
 HCHSA-50-4.5

Place the cable end even with far side of the tap hole. Pressure must be applied to the closed mold cover to hold the mold in place.

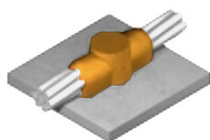
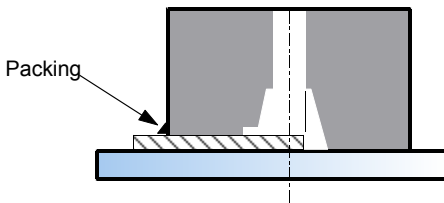

HCHST

Cable	Mold Code	Weld Metal	Price Key	Handle Clamp
10	HCHST10	45	F2	FF
16	HCHST16	45	F2	FF
25	HCHST25	45	F2	FF
35	HCHST35	45	F2	FF
50	HCHST50	65	F2	FF

Cable on surface.
 Cable to pipe - Use Mold code with suffix for 12" and smaller pipe.

Example : 50 cable to 4 1/2 " pipe.
 HCHST-50-4.5

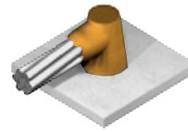
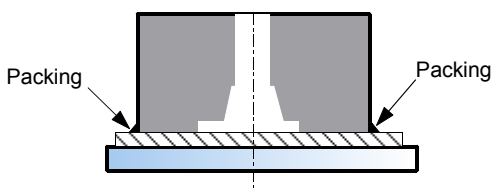

HCHS

Cable	Mold Code	Weld Metal	Price Key	Handle Clamp
95	HCHS95	115	M	EC-M
120	HCHS120	115	M	EC-M
150	HCHS150	150	H	EC-M
185	HCHS185	200	H	EC-M
240	HCHS240	200	H	EC-M
300	HCHS300	250	H	EC-M

Cable off surface.
 Cable to pipe - Use Mold code with suffix for 28" and smaller pipe.

Example : 95 cable to 12 " pipe.
 HCHS-95-12.0

Place the cable end 3mm short of the center of the tap hole. Pressure must be applied to the closed mold cover to hold the mold in place.

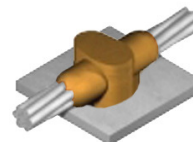
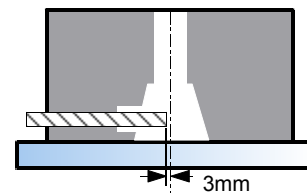

HCHSTB

Cable	Mold Code	Weld Metal	Price Key	Handle Clamp
70	HCHSTB70	115	H	EC-M
95	HCHSTB95	150	H	EC-M
120	HCHSTB120	150	H	EC-M
150	HCHSTB150	200	H	EC-M
185	HCHSTB185	250	H	EC-M
240	HCHSTB240	2 X 150	J	EC-L
300	HCHSTB300	2 X 200	J	EC-L

Cable off surface.
 Cable to pipe - Use Mold code with suffix for 28" and smaller pipe.

Example : 95 cable to 12 " pipe.
 HCHSTB-95-12.0

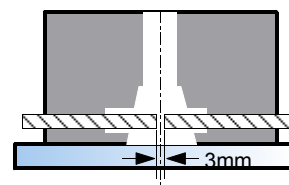

Cable to Flat/Round

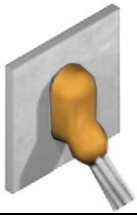

ADVS

Cable	Mold Code	Weld Metal	Price Key	Handle Clamp
16 mm ²	ADVS16	45	M	EC-M
25	ADVS25	45	M	EC-M
30	ADVS30	45	M	EC-M
35	ADVS35	45	M	EC-M
50	ADVS50	65	M	EC-M
70	ADVS70	90	M	EC-M
95	ADVS95	115	H	EC-M
120	ADVS120	115	H	EC-M
150	ADVS150	150	H	EC-M
185	ADVS185	200	H	EC-M
240	ADVS240	200	H	EC-M
300	ADVS300	250	H	EC-M

Secure mold to surface with appropriate clamp.

Cable to vertical pipe

- The pipe diameter must be notified when ordering the molds.
- Use Mold code with suffix.

Example : 70 mmsq cable to 4-1/2 " pipe.
ADVS-70-4.5

Place the cable and mold into position as shown.
Secure mold to the surface using a C clamp.

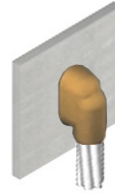
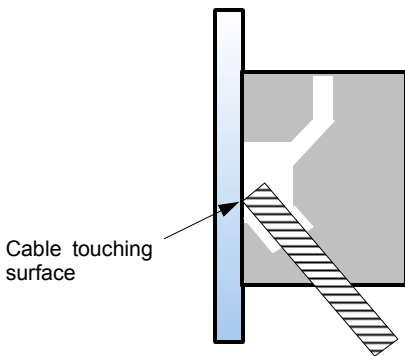

CDVS

Cable	Mold Code	Weld Metal	Price Key	Handle Clamp
16mm ²	CDVS16	65	M	EC-M
25	CDVS25	65	M	EC-M
30	CDVS30	65	M	EC-M
35	CDVS35	90	M	EC-M
50	CDVS50	90	M	EC-M
70	CDVS70	150	H	EC-M
95	CDVS95	150	H	EC-M
120	CDVS120	200	H	EC-M
150	CDVS150	200	H	EC-M
185	CDVS185	250	H	EC-M
240	CDVS240	2 X 150	J	EC-L
300	CDVS300	2 X 200	J	EC-L

Secure mold to surface with appropriate clamp.

Cable to vertical pipe

- The pipe diameter must be notified when ordering the molds.
- Use Mold code with suffix.

Example : 70 mmsq cable to 4-1/2 " pipe.
CDVS-70-4.5

Place the cable and mold into position as shown.
Secure mold to the surface using a C clamp.

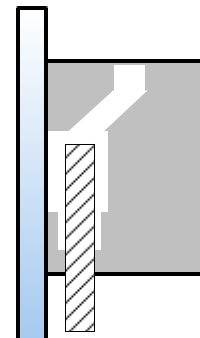

Cable to Flat/Round

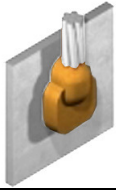

VCVS

Cable	Mold Code	Weld Metal	Price Key	Handle Clamp
16	VCVS16	65	J	EC-M
25	VCVS25	65	J	EC-M
30	VCVS30	65	J	EC-M
35	VCVS35	90	J	EC-M
50	VCVS50	115	J	EC-M
70	VCVS70	150	J	EC-M
95	VCVS95	200	J	EC-M
120	VCVS120	200	J	EC-M
150	VCVS150	250	M+	EC-M
185	VCVS185	2 X 150	L+	EC-L
240	VCVS240	2 X 200	L+	EC-L
300	VCVS300	2 X 200	L+	EC-L

Secure mold to surface with appropriate clamp.
 Cable to vertical pipe
 - The pipe diameter must be notified when ordering the molds.
 - Use Mold code with suffix.

Example : 70 mmsq cable to 4-1/2 " pipe.
 VCVS-70-4.5

Place the cable into position in the mold ensuring that it is firmly against the steel surface. The end of the cable must be positioned against the bottom of the weld cavity. The mold should be secured to the steel surface using a C clamp.

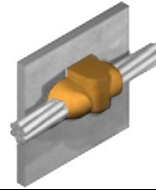
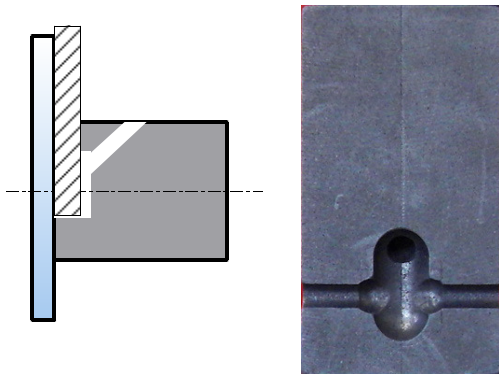

HCVS

Cable	Mold Code	Weld Metal	Price Key	Handle Clamp
10 mm2	HCVS10	45	M	EC-M
16	HCVS16	45	M	EC-M
25	HCVS25	45	M	EC-M
30	HCVS30	45	M	EC-M
35	HCVS35	45	M	EC-M
50	HCVS50	90	H	EC-M

Cable on surface.
 Secure mold to surface with appropriate clamp.
 Cable to horizontal pipe
 - Use Mold code with suffix for 12" and smaller pipe.

Example : 50 cable to 4 1/2 " pipe.
 HCVS-50-4.5

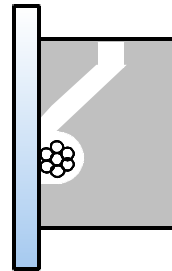

Place the cable and mold into position as shown.
 Secure mold to the surface using a C clamp.
 Use packing material at both side.

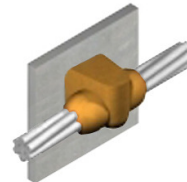

HCVS SB

Cable	Mold Code	Weld Metal	Price Key	Handle Clamp
16 mm2	HCVSB16	65	M	EC-M
25	HCVSB25	65	M	EC-M
30	HCVSB30	65	M	EC-M
35	HCVSB35	90	M	EC-M
50	HCVSB50	115	M	EC-M
70	HCVSB70	150	L	EC-M
95	HCVSB95	150	L	EC-M
120	HCVSB120	150	L	EC-M
150	HCVSB150	200	L	EC-M
185	HCVSB185	250	L	EC-M
240	HCVSB240	2 X 150	L+	EC-L
300	HCVSB300	2 X 200	L+	EC-L

Cable off surface.
 Secure mold to surface with appropriate clamp.
 Cable to horizontal pipe
 - Use Mold code with suffix for 28" and smaller pipe.

Example : 95 cable to 12 " pipe.
 HCHSTB-95-12.0

Cable to Lug / Tape

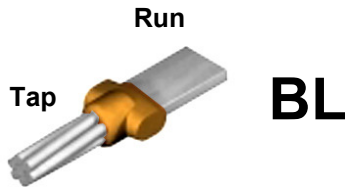

A(Run)	B(Tap)	Mold Code	Weld Metal	Price Key	Handle Clamp
2 X 20mm	10	BL10/202	32	M	EC-M
2 X 20	25	BL25/202	32	M	EC-M
3 X 25	16	BL16/253	45	M	EC-M
3 X 25	25	BL25/253	45	M	EC-M
3 X 25	30	BL30/253	45	M	EC-M
3 X 25	35	BL35/253	45	M	EC-M
3 X 25	50	BL50/253	65	M	EC-M
3 X 25	70	BL70/253	65	M	EC-M
3 X 25	95	BL95/253	65	M	EC-M
4 X 25	50	BL50/254	65	M	EC-M
4 X 25	70	BL70/254	65	M	EC-M
4 X 25	95	BL95/254	90	M	EC-M
5 X 25	50	BL50/255	65	M	EC-M
5 X 25	95	BL95/255	90	M	EC-M
5 X 25	70	BL70/255	65	M	EC-M
5 X 25	120	BL120/255	90	M	EC-M
2 X 30	25	BL25/302	45	M	EC-M
2 X 30	35	BL35/302	45	M	EC-M
2 X 30	50	BL50/302	45	M	EC-M
3 X 30	35	BL35/303	45	M	EC-M
3 X 30	50	BL50/303	65	M	EC-M
3 X 30	70	BL70/303	90	M	EC-M
3 X 30	95	BL95/303	90	M	EC-M
5 X 30	95	BL95/305	90	M	EC-M
5 X 30	120	BL120/305	115	M	EC-M
5 X 30	150	BL150/305	115	H	EC-M
3 X 40	70	BL70/403	90	M	EC-M
3 X 40	95	BL95/403	90	M	EC-M
3 X 40	120	BL120/403	115	M	EC-M
5 X 40	70	BL70/405	65	M	EC-M
5 X 40	95	BL95/405	90	M	EC-M
5 X 40	120	BL120/405	115	H	EC-M
5 X 40	150	BL150/405	150	H	EC-M
5 X 40	185	BL185/405	150	H	EC-M
5 X 50	95	BL95/505	90	H	EC-M
5 X 50	120	BL120/505	115	H	EC-M
5 X 50	150	BL150/505	150	H	EC-M
5 X 50	185	BL185/505	200	H	EC-M
5 X 50	240	BL240/505	200	H	EC-M
5 X 50	300	BL300/505	200	H	EC-M
6 X 50	70	BL70/506	65	H	EC-M
6 X 50	95	BL95/506	90	H	EC-M
6 X 50	120	BL120/506	115	H	EC-M
6 X 50	150	BL150/506	150	H	EC-M
6 X 50	185	BL185/506	200	H	EC-M
6 X 50	240	BL240/506	250	M+	EC-L
6 X 50	300	BL300/506	2 X 150	M+	EC-L

A(Run)	B(Tap)	Mold Code	Weld Metal	Price Key	Handle Clamp
8 X 50	185	BL185/508	200	H	EC-M
8 X 50	240	BL240/508	2 X 150	M+	EC-L
8 X 50	300	BL300/508	2 X 200	L+	EC-L
10 X 50	300	BL300/5010	2 X 200	L+	EC-L
10 X 50	500	BL500/5010	2 X 200	L+	EC-L
12 X 50	500	BL500/5012	2 X 250	L+	EC-L
5 X 60	185	BL185/605	250	M+	EC-L
5 X 60	240	BL240/605	250	M+	EC-L
5 X 60	300	BL300/605	2 X 150	M+	EC-L
6 X 60	120	BL120/606	115	M+	EC-L
6 X 75	95	BL95/756	90	M+	EC-L
6 X 75	120	BL120/756	115	M+	EC-L
6 X 75	150	BL150/756	150	M+	EC-L
6 X 75	185	BL185/756	200	M+	EC-L
6 X 75	240	BL240/756	250	M+	EC-L
6 X 75	300	BL300/756	2 X 150	M+	EC-L
8 X 75	185	BL185/758	200	M+	EC-L
8 X 75	240	BL240/758	2 X 150	M+	EC-L
8 X 75	300	BL300/758	2 X 200	L+	EC-L
8 X 75	500	BL500/758	2 X 200	L+	EC-L
10 X 75	500	BL500/7510	2 X 200	L+	EC-L
12 X 75	500	BL500/7512	2 X 250	L+	EC-L

Place the cable and lug/tape into position in the mold with ends butted center of the tap hole.

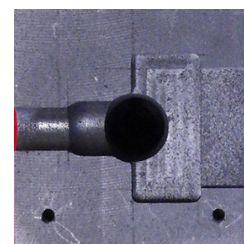
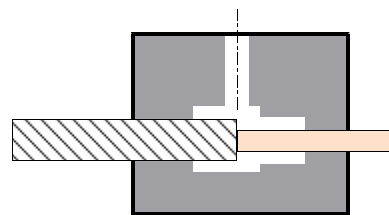

Cable to Lug / Tape

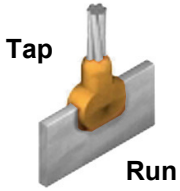

VOCB

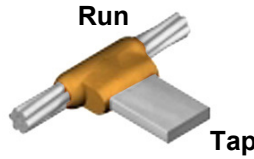

HBCT

A(Run)	B(Tap)	Mold Code	Weld Metal	Price Key	Handle Clamp
	35	VOCB35/3	115	J	EC-M
3 x 25	50	VOCB50/3	115	J	EC-M
&	70	VOCB70/3	115	J	EC-M
Wider	95	VOCB95/3	115	J	EC-M
	120	VOCB120/3	115	J	EC-M
	150	VOCB150/3	150	J	EC-M
	240	VOCB240/3	250	M+	EC-M
	50	VOCB50/5	150	J	EC-M
	70	VOCB70/5	150	J	EC-M
5 x 25	95	VOCB95/5	150	J	EC-M
&	120	VOCB120/5	150	J	EC-M
Wider	150	VOCB150/5	200	J	EC-M
	185	VOCB185/5	200	J	EC-M
	240	VOCB240/5	2 x 150	M+	EC-L
	10	VOCB10/256	115	J	EC-M
	70	VOCB70/6	150	J	EC-M
6 x 25	95	VOCB95/6	150	J	EC-M
	120	VOCB120/6	150	J	EC-M
	150	VOCB150/6	200	J	EC-M
	240	VOCB240/6	2 x 150	M+	EC-L
	70	VOCB70/6	150	J	EC-M
6 x 50	240	VOCB240/6	2 x 150	M+	EC-L
	300	VOCB300/6	2 x 150	M+	EC-L
	50	VOCB50/10	150	J	EC-M
	70	VOCB70/10	150	J	EC-M
10 x 30	95	VOCB95/10	150	J	EC-M
&	120	VOCB125/10	150	J	EC-M
Wider	150	VOCB150/10	200	J	EC-M
	185	VOCB185/10	200	J	EC-M
	240	VOCB240/10	2 x 150	M+	EC-M
	300	VOCB300/10	2 x 150	M+	EC-L

Place the cable and tape into position in the mold. Ensure there is a 3-5 mm gap between cable and the tape. Use pliers to hold the cable and confirm the mold is tightly seated on the tape.

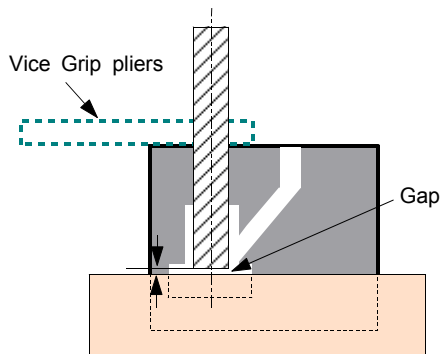

A(Run)	B(Tap)	Mold Code	Weld Metal	Price Key	Handle Clamp
10		HBCT10/202	45	M	EC-M
16	2 X 20	HBCT16/202	45	M	EC-M
25		HBCT25/202	45	M	EC-M
35		HBCT35/202	45	M	EC-M
25		HBCT25/302	45	M	EC-M
35	2 X 30	HBCT35/302	45	M	EC-M
50		HBCT50/302	65	M	EC-M
35		HBCT35/253	45	M	EC-M
50		HBCT50/253	65	M	EC-M
70		HBCT70/253	90	M	EC-M
95	3 X 25	HBCT95/253	90	M	EC-M
120		HBCT120/253	115	M	EC-M
150		HBCT150/253	150	M	EC-M
240		HBCT150/253	200	M	EC-M
300		HBCT300/253	250	M	EC-M
35		HBCT35/303	65	M	EC-M
50	3 X 30	HBCT50/303	90	M	EC-M
70		HBCT70/303	115	M	EC-M
95		HBCT95/305	150	H	EC-M
120		HBCT120/305	200	H	EC-M
150	5 X 30	HBCT150/305	200	H	EC-M
240		HBCT240/305	250	H	EC-M
400		HBCT400/305	2 X 150	M+	EC-L
50		HBCT50/403	115	M	EC-M
70		HBCT70/403	115	M	EC-M
95	3 X 40	HBCT95/403	150	H	EC-M
120		HBCT120/403	200	H	EC-M
240		HBCT240/403	2 X 150	M+	EC-L
120		HBCT120/405	200	H	EC-M
150	5 X 40	HBCT150/405	250	H	EC-M
185		HBCT185/405	250	H	EC-M
70		HBCT70/505	200	M+	EC-L
150	5 X 50	HBCT150/505	250	M+	EC-L
185		HBCT185/505	2 X 150	M+	EC-L
240		HBCT240/505	2 X 150	M+	EC-L
150		HBCT150/605	2 X 150	M+	EC-L
185	5 X 60	HBCT185/605	2 X 200	L+	EC-L
240		HBCT240/605	2 X 200	L+	EC-L
300		HBCT300/605	2 X 200	L+	EC-L
240	6 X 50	HBCT240/506	2 X 200	L+	EC-L
300		HBCT300/506	2 X 250	L+	EC-L

Place the cable and lug/tape into position in the mold, with lug/tape butted against the side of the cable.

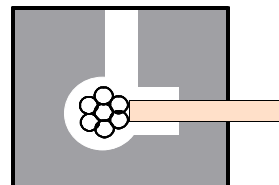

Cable to Lug / Tape

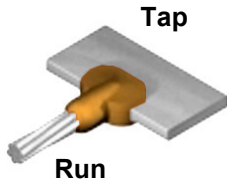

HBHC

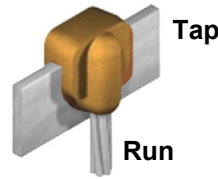

HBVC

A(Run)	B(Tap)	Mold Code	Weld Metal	Price Key	Handle Clamp
16	2 X 25	HBHC16/252	32	M	EC-M
25	2 X 25	HBHC25/252	32	M	EC-M
35	2 X 25	HBHC35/252	45	M	EC-M
50	2 X 25	HBHC50/252	45	M	EC-M
35	3 X 25	HBHC35/253	45	M	EC-M
50	3 X 25	HBHC50/253	45	M	EC-M
70	3 X 25	HBHC70/253	65	M	EC-M
95	3 X 25	HBHC95/253	90	M	EC-M
120	3 X 25	HBHC120/253	90	M	EC-M
150	3 X 25	HBHC150/253	115	M	EC-M
185	3 X 25	HBHC185/253	115	M	EC-M
240	3 X 25	HBHC240/253	150	H	EC-M
35	3 X 30	HBHC35/303	45	M	EC-M
50	3 X 30	HBHC50/303	65	M	EC-M
70	3 X 30	HBHC70/303	90	M	EC-M
35	3 X 40	HBHC35/403	45	M	EC-M
50	3 X 40	HBHC50/403	90	M	EC-M
95	3 X 40	HBHC95/403	90	M	EC-M
120	3 X 40	HBHC120/403	115	M	EC-M
35	5 X 40	HBHC35/405	65	M	EC-M
50	5 X 40	HBHC50/405	90	M	EC-M
95	5 X 40	HBHC95/405	90	M	EC-M
120	5 X 40	HBHC120/405	115	M	EC-M
150	5 X 40	HBHC150/405	115	M	EC-M
185	5 X 40	HBHC185/405	150	H	EC-M
50	6 X 40	HBHC50/406	90	M	EC-M
95	6 X 40	HBHC95/406	90	M	EC-M
120	6 X 40	HBHC120/406	115	M	EC-M
185	6 X 40	HBHC185/406	150	H	EC-M
240	6 X 40	HBHC240/406	200	H	EC-M
70	5 X 50	HBHC70/505	90	M	EC-M
95	5 X 50	HBHC95/505	90	M	EC-M
120	5 X 50	HBHC120/505	115	M	EC-M
150	5 X 50	HBHC150/505	115	M	EC-M
185	5 X 50	HBHC185/505	150	H	EC-M
240	5 X 50	HBHC240/505	200	H	EC-M
150	6 X 50	HBHC150/506	115	M	EC-M
185	6 X 50	HBHC185/506	150	H	EC-M
240	6 X 50	HBHC240/506	200	H	EC-M
300	6 X 50	HBHC300/506	250	M+	EC-L

Place the cable and tape into position in the mold ensuring the cable butts against the tape. The mold should be tightly seated on the tape.

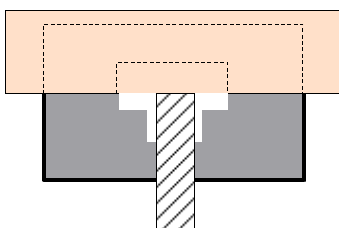

A(Run)	B(Tap)	Mold Code	Weld Metal	Price Key	Handle Clamp
10mm2		HBVC10/2	45	H	EC-M
16		HBVC16/2	45	H	EC-M
25	2 X 25	HBVC25/2	45	H	EC-M
30		HBVC30/2	65	H	EC-M
50		HBVC50/2	65	H	EC-M
10		HBVC10/3	65	H	EC-M
30		HBVC30/3	65	H	EC-M
35		HBVC35/3	65	H	EC-M
50	3 X 25	HBVC50/3	90	H	EC-M
70		HBVC70/3	90	H	EC-M
95		HBVC95/3	115	H	EC-M
120		HBVC120/3	115	H	EC-M
150		HBVC150/3	150	H	EC-M
185		HBVC185/3	150	H	EC-M
10		HBVC10/4	90	H	EC-M
70	4 X 25	HBVC70/4	115	H	EC-M
95		HBVC95/4	150	H	EC-M
120	5 X 30	HBVC120/5	150	H	EC-M
150		HBVC150/5	200	H	EC-M
185	5 X 50	HBVC185/5	200	H	EC-M
240		HBVC240/5	250	H	EC-M
240	6 X 50	HBVC240/6	250	H	EC-M
300		HBVC300/6	2 X 200	J	EC-L
300	8 X 50	HBVC300/8	2 X 200	J	EC-L
50		HBVC50/10	115	H	EC-M
70		HBVC70/10	115	H	EC-M
95		HBVC95/10	150	H	EC-M
120	10 X 50	HBVC120/10	150	H	EC-M
150	&	HBVC150/10	200	H	EC-M
185	WIDER	HBVC185/10	200	H	EC-M
240		HBVC240/10	250	H	EC-M
300		HBVC300/10	250	H	EC-M
400		HBVC400/10	2 X 200	J	EC-L
500		HBVC500/10	2 X 250	L+	EC-L

Place the cable and tape into position in the mold ensuring the cable end is even with the top of the tape. Use packing material around the cable to avoid leaking.

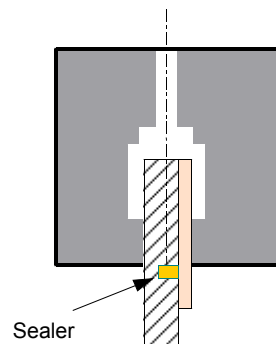

Tape to Tape

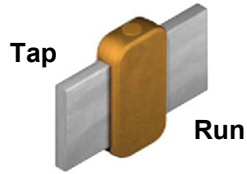

VBB

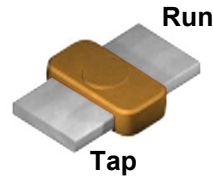

HBB

A(Run)	B(Tap)	Mold Code	Weld Metal	Price Key	Handle Clamp
2 X 20	2 X 20	VBB202	45	M	EC-M
3 X 20	3 X 20	VBB203	45	M	EC-M
5 X 20	5 X 20	VBB205	65	M	EC-M
2 X 25	2 X 25	VBB252	65	M	EC-M
3 X 25	3 X 25	VBB253	65	M	EC-M
4 X 25	4 X 25	VBB254	90	H	EC-M
5 X 25	5 X 25	VBB255	115	H	EC-M
6 X 25	6 X 25	VBB256	115	H	EC-M
2 X 30	2 X 30	VBB302	65	M	EC-M
3 X 30	3 X 30	VBB303	90	H	EC-M
4 X 30	4 X 30	VBB304	115	H	EC-M
5 X 30	5 X 30	VBB305	115	H	EC-M
3 X 40	3 X 40	VBB403	115	H	EC-M
4 X 40	4 X 40	VBB404	150	H	EC-M
5 X 40	5 X 40	VBB405	150	H	EC-M
6 X 40	6 X 40	VBB406	200	H	EC-M
10 X 40	10 X 40	VBB4010	250	H	EC-M
3 X 50	3 X 50	VBB503	90	H	EC-M
4 X 50	4 X 50	VBB504	115	H	EC-M
5 X 50	5 X 50	VBB505	200	H	EC-M
6 X 50	6 X 50	VBB506	250	H	EC-M
8 X 50	8 X 50	VBB508	2 X 150	J	EC-L
10 X 50	10 X 50	VBB5010	2 X 200	L+	EC-L
5 X 60	5 X 60	VBB605	250	H	EC-M
6 X 60	6 X 60	VBB606	250	H	EC-M
8 X 60	8 X 60	VBB608	2 X 200	L+	EC-L
10 X 60	10 X 60	VBB6010	2 X 250	L+	EC-L
5 X 80	5 X 80	VBB805	2 X 200	L+	EC-L
6 X 80	6 X 80	VBB806	2 X 200	L+	EC-L
8 X 80	8 X 80	VBB808	2 X 250	L+	EC-L
10 X 80	10 X 80	VBB8010	3 X 200	L+	EC-L
5 X 100	5 X 100	VBB1005	2 X 250	L+	EC-L
10 X 100	10 X 100	VBB10010	3 X 250	L+	EC-L

A(Run)	B(Tap)	Mold Code	Weld Metal	Price Key	Handle Clamp
2 X 20	2 X 20	HBB202	45	M	EC-M
3 X 20	3 X 20	HBB203	45	M	EC-M
4 X 20	4 X 20	HBB204	65	M	EC-M
5 X 20	5 X 20	HBB205	90	M	EC-M
2 X 25	2 X 25	HBB252	45	M	EC-M
3 X 25	3 X 25	HBB253	65	M	EC-M
4 X 25	4 X 25	HBB254	90	M	EC-M
5 X 25	5 X 25	HBB255	115	M	EC-M
6 X 25	6 X 25	HBB256	115	M	EC-M
2 X 30	2 X 30	HBB302	65	M	EC-M
3 X 30	3 X 30	HBB303	65	M	EC-M
4 X 30	4 X 30	HBB304	90	M	EC-M
5 X 30	5 X 30	HBB305	115	M	EC-M
3 X 40	3 X 40	HBB403	90	M	EC-M
4 X 40	4 X 40	HBB404	115	M	EC-M
5 X 40	5 X 40	HBB405	150	H	EC-M
6 X 40	6 X 40	HBB406	200	H	EC-M
10 X 40	10 X 40	HBB4010	2 X 150	M+	EC-L
3 X 50	3 X 50	HBB503	150	M+	EC-L
5 X 50	5 X 50	HBB505	200	M+	EC-L
6 X 50	6 X 50	HBB506	250	M+	EC-L
8 X 50	8 X 50	HBB508	2 X 150	M+	EC-L
10 X 50	10 X 50	HBB5010	2 X 200	L+	EC-L
5 X 60	5 X 60	HBB605	2 X 150	M+	EC-L
6 X 60	6 X 60	HBB606	2 X 150	M+	EC-L
8 X 60	8 X 60	HBB608	2 X 200	L+	EC-L
10 X 60	10 X 60	HBB6010	2 X 250	L+	EC-L
8 X 80	5 X 80	HBB805	2 X 200	L+	EC-L
10 X 80	10 X 80	HBB8010	3 X 200	L+	EC-L

Place tapes into position in the mold. Ensure gap between tapes is centered under the tap hole.
 For thickness ≤ 3mm : gap = 3mm
 For thickness > 3mm : gap = 5~6mm

Place tapes into position in the mold. Ensure gap between tapes is centered under the tap hole.
 For thickness ≤ 3mm : gap = 3mm
 For thickness > 3mm : gap = 5~6mm

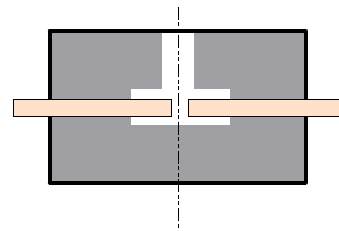
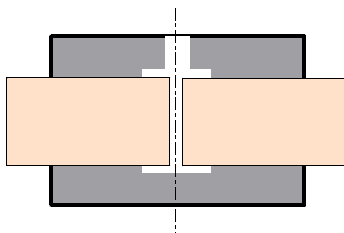

Tape to Tape

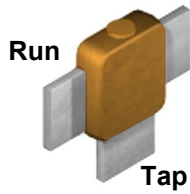

VBDT

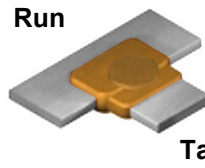

HBT

A(Run)	B(Tap)	Mold Code	Weld Metal	Price Key	Handle Clamp
2 X 20	2 X 20	VBDT202	45	M	EC-M
3 X 20	3 X 20	VBDT203	65	M	EC-M
5 X 20	5 X 20	VBDT205	65	M	EC-M
2 X 25	2 X 25	VBDT252	65	M	EC-M
3 X 25	3 X 25	VBDT253	90	M	EC-M
4 X 25	4 X 25	VBDT254	90	H	EC-M
6 X 25	6 X 25	VBDT256	150	H	EC-M
2 X 30	2 X 30	VBDT302	65	M	EC-M
3 X 30	3 X 30	VBDT303	90	H	EC-M
4 X 30	4 X 30	VBDT304	115	H	EC-M
5 X 30	5 X 30	VBDT305	115	H	EC-M
3 X 40	3 X 40	VBDT403	115	H	EC-M
4 X 40	4 X 40	VBDT404	150	H	EC-M
5 X 40	5 X 40	VBDT405	150	H	EC-M
6 X 40	6 X 40	VBDT406	200	H	EC-M
10 X 40	10 X 40	VBDT4010	2 X 150	L+	EC-L
5 X 50	5 X 50	VBDT505	200	J	EC-L
6 X 50	6 X 50	VBDT506	250	J	EC-L
8 X 50	8 X 50	VBDT508	2 X 150	L+	EC-L
10 X 50	10 X 50	VBDT508	2 X 200	L+	EC-L
5 X 60	5 X 60	VBDT605	2 X 150	L+	EC-L
6 X 60	6 X 60	VBDT606	2 X 150	L+	EC-L
8 X 60	8 X 60	VBDT608	2 X 200	L+	EC-L
10 X 60	10 X 60	VBDT6010	2 X 250	L+	EC-L
5 X 80	5 X 80	VBDT805	2 X 200	L+	EC-L
6 X 80	6 X 80	VBDT806	2 X 200	L+	EC-L
8 X 80	8 X 80	VBDT808	2 X 250	L+	EC-L
10 X 80	10 X 80	VBDT8010	3 X 200	L+	EC-L

Place tapes into position in the mold with the end of the tap tape even with the top edge of the run tape.

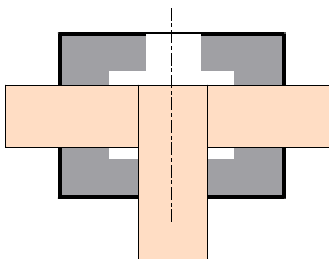

A(Run)	B(Tap)	Mold Code	Weld Metal	Price Key	Handle Clamp
2 x 20	2 x 20	HBT202	45	M	EC-M
3 X 20	3 X 20	HBT203	45	M	EC-M
4 X 20	4 X 20	HBT204	65	M	EC-M
5 X 20	5 X 20	HBT205	90	M	EC-M
2 X 25	2 X 25	HBT252	45	M	EC-M
3 X 25	3 X 25	HBT253	65	M	EC-M
4 X 25	4 X 25	HBT254	90	M	EC-M
5 X 25	5 X 25	HBT255	90	M	EC-M
6 X 25	6 X 25	HBT256	115	M	EC-M
6 X 25	3 X 25	HBT256/253	115	M	EC-M
2 X 30	2 X 30	HBT302	65	M	EC-M
3 X 30	3 X 30	HBT303	65	M	EC-M
4 X 30	4 X 30	HBT304	90	M	EC-M
5 X 30	5 X 30	HBT305	115	M	EC-M
5 X 30	6 X 50	HBT305/506	250	M+	EC-L
3 X 40	3 X 40	HBT403	90	M	EC-M
4 X 40	4 X 40	HBT404	115	M	EC-M
5 X 40	5 X 40	HBT405	150	H	EC-M
6 X 40	6 X 40	HBT406	200	H	EC-M
10 X 40	6 X 50	HBT4010/506	2 X 150	M+	EC-L
10 X 40	10 X 40	HBT4010	2 X 150	M+	EC-L
3 X 50	3 X 50	HBT503	200	M+	EC-L
4 X 50	4 X 50	HBT504	200	M+	EC-L
5 X 50	5 X 50	HBT505	200	M+	EC-L
6 X 50	3 X 25	HBT506/253	115	M+	EC-L
6 X 50	5 X 30	HBT506/305	200	M+	EC-L
6 X 50	4 X 50	HBT506/504	250	M+	EC-L
6 X 50	6 X 50	HBT506	250	M+	EC-L
6 X 50	10 X 60	HBT506/6010	2 X 150	M+	EC-L
8 X 50	8 X 50	HBT508	2 X 150	M+	EC-L
10 X 50	10 X 50	HBT5010	2 X 200	L+	EC-L
5 X 60	5 X 60	HBT605	2 X 150	M+	EC-L
6 X 60	6 X 60	HBT606	2 X 150	M+	EC-L
8 X 60	8 X 60	HBT608	2 X 200	L+	EC-L
10 X 60	10 X 60	HBT6010	2 X 250	L+	EC-L
5 X 80	5 X 80	HBT805	2 X 200	L+	EC-L
10 X 80	10 X 80	HBT8010	3 X 200	L+	EC-L

Place tapes into position in the mold ensuring both run and tap tapes are tightly seated in position.

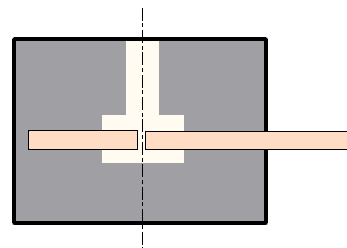

Tape to Tape

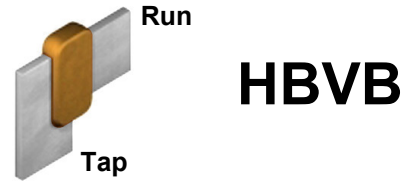
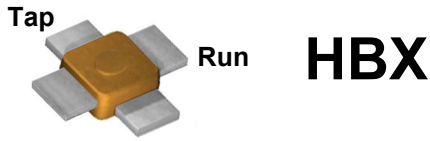

A(Run)	B(Tap)	Mold Code	Weld Metal	Price Key	Handle Clamp
2 X 20	2 X 20	HBX202	90	M	EC-M
2.5 X 20	2.5 X 20	HBX202.5	90	M	EC-M
3 X 20	3 X 20	HBX203	90	M	EC-M
4 X 20	4 X 20	HBX204	90	M	EC-M
5 X 20	5 X 20	HBX205	115	M	EC-M
2 X 25	2 X 25	HBX252	115	M	EC-M
3 X 25	3 X 25	HBX253	115	M	EC-M
4 X 25	4 X 25	HBX254	150	H	EC-M
5 X 25	5 X 25	HBX255	150	H	EC-M
6 X 25	6 X 25	HBX256	150	H	EC-M
2 X 30	2 X 30	HBX302	90	M	EC-M
3 X 30	3 X 30	HBX303	115	M	EC-M
3.5 X 30	3.5 X 30	HBX303.5	115	M	EC-M
4 X 30	4 X 30	HBX304	200	H	EC-M
5 X 30	5 X 30	HBX305	200	H	EC-M
3 X 40	3 X 40	HBX403	250	M+	EC-L
4 X 40	4 X 40	HBX404	2 x 150	M+	EC-L
5 X 40	5 X 40	HBX405	2 X 200	L+	EC-L
6 X 40	6 X 40	HBX406	3 X 150	L+	EC-L
10 X 40	10 X 40	HBX4010	2 X 250	L+	EC-L
3 X 50	3 X 50	HBX503	250	L+	EC-L
3 X 50G	3 X 50G	HBX503G	2 X 150	L+	EC-L
4 X 50	4 X 50	HBX504	2 X 200	L+	EC-L
5 X 50	5 X 50	HBX505	2 X 200	L+	EC-L
6 X 50	6 X 50	HBX506	2 X 250	L+	EC-L
8 X 50	8 X 50	HBX508	2 X 250	L+	EC-L
6 X 50	10 X 60	HBX506/6010	3 X 200	L+	EC-L

A(Run)	B(Tap)	Mold Code	Weld Metal	Price Key	Handle Clamp
2 X 20	2 X 20	HBVB202	45	M	EC-M
3 X 20	3 X 20	HBVB203	45	M	EC-M
5 X 20	5 X 20	HBVB205	45	M	EC-M
2 X 25	2 X 25	HBVB252	45	H	EC-M
3 X 25	3 X 25	HBVB253	65	H	EC-M
4 X 25	4 X 25	HBVB254	65	H	EC-M
5 X 25	5 X 25	HBVB255	115	H	EC-M
6 X 25	6 X 25	HBVB256	115	H	EC-M
2 X 30	2 X 30	HBVB302	65	H	EC-M
3 X 30	3 X 30	HBVB303	65	H	EC-M
4 X 30	4 X 30	HBVB304	115	H	EC-M
5 X 30	5 X 30	HBVB305	115	H	EC-M
3 X 40	3 X 40	HBVB403	65	H	EC-M
4 X 40	4 X 40	HBVB404	115	H	EC-M
5 X 40	5 X 40	HBVB405	150	H	EC-M
6 X 40	6 X 40	HBVB406	200	H	EC-M
3 X 50	3 X 50	HBVB503	90	R	EC-M
4 X 50	4 X 50	HBVB504	115	R	EC-M
5 X 50	5 X 50	HBVB505	115	R	EC-M
6 X 50	6 X 50	HBVB506	200	R	EC-M
8 X 50	8 X 50	HBVB508	250	R	EC-M
10 X 50	10 X 50	HBVB5010	2 X 150	J	EC-L

Place tapes into position in the mold ensuring both run and tap tapes are tightly seated in position.

Place tapes into position in the mold ensuring both run and tap tapes are tightly seated in position. End of the tap tape must be even with top edge of the run tape. Ensure gap between tapes is centered under the tap hole.

For thickness ≤ 3mm : gap = 3mm
 For thickness > 3mm : gap = 5-6mm

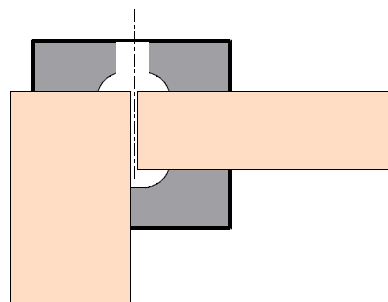
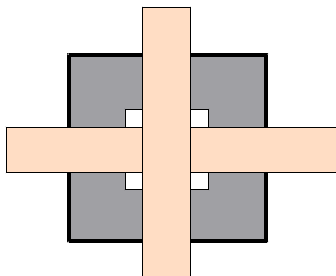

SRG tapes welding

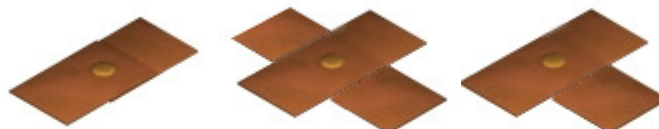

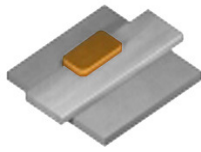

HBSS

Conductor	Mold Code	Weld Metal	Price Key	Handle Clamp
2 X 20	HBSS202	65	M	EC-M
2 X 25	HBSS252	90	H	EC-M
3 X 20	HBSS203	90	H	EC-M
3 X 25	HBSS253	115	H	EC-M
3 X 30	HBSS303	115	H	EC-M
3 X 40	HBSS403	150	H	EC-M
4 X 25	HBSS254	115	H	EC-M
4 X 30	HBSS304	150	H	EC-M
4 X 40	HBSS404	200	H	EC-M
5 X 25	HBSS255	150	H	EC-M
5 X 30	HBSS305	200	H	EC-M
5 X 40	HBSS405	200	H	EC-M
5 X 50	HBSS505	200	H	EC-M
6 X 25	HBSS256	150	H	EC-M
6 X 30	HBSS306	200	H	EC-M
6 X 40	HBSS406	250	H	EC-M
6 X 50	HBSS506	250	H	EC-M

Place the tape into position in the mold ensuring the tape is tightly seated to both the steel plate and the edge of the tape. Pressure must be applied on the closed mold cover to hold the mold in place.

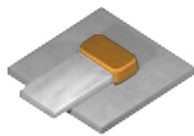
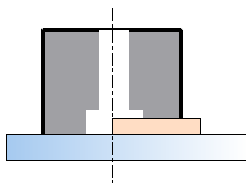

BHS

Conductor	Mold Code	Weld Metal	Price Key	Handle Clamp
2 X 20	BHS202	65	M	EC-M
3 X 20	BHS203	90	M	EC-M
3 X 25	BHS253	90	M	EC-M
5 X 25	BHS255	115	M	EC-M
2 X 30	BHS302	90	M	EC-M
3 X 30	BHS303	115	M	EC-M
4 X 30	BHS304	150	H	EC-M
5 X 30	BHS305	200	H	EC-M
1.5 X 40	BHS40/1.5	65	M	EC-M
3 X 40	BHS403	115	M	EC-M
4 X 40	BHS404	200	H	EC-M
5 X 40	BHS405	200	H	EC-M
6 X 40	BHS406	250	H	EC-M
5 X 50	BHS505	2 X 150	J	EC-L
6 X 50	BHS506	2 X 150	J	EC-L
8 X 50	BHS508	2 X 200	J	EC-L

Place tape into position in the mold ensuring the end of the tape is centered under the tap hole. Pressure must be applied on the closed mold cover to hold the mold in place.

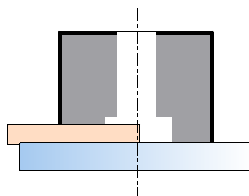

Tape to Flat



BVS

Conductor	Mold Code	Weld Metal	Price Key	Handle Clamp
2 X 20mm	BVS202	65	M	EC-M
3 X 20	BVS203	65	M	EC-M
2 X 25	BVS252	90	H	EC-M
3 X 25	BVS253	90	H	EC-M
4 X 25	BVS254	90	H	EC-M
5 X 25	BVS255	115	H	EC-M
6 X 25	BVS256	150	H	EC-M
2 X 30	BVS302	90	H	EC-M
3 X 30	BVS303	90	H	EC-M
4 X 30	BVS304	115	H	EC-M
5 X 30	BVS305	150	H	EC-M
3 X 40	BVS403	150	H	EC-M
4 X 40	BVS404	200	H	EC-M
5 X 40	BVS405	200	H	EC-M
6 X 40	BVS406	250	H	EC-M
3 X 50	BVS503	200	J	EC-L
5 X 50	BVS505	250	J	EC-L
6 X 50	BVS506	2 X 150	J	EC-L
8 X 50	BVS508	2 X 200	J	EC-L
6 X 60	BVS606	2 X 200	J	EC-L
8 X 60	BVS608	2 X 250	L+	EC-L
10 X 60	BVS6010	3 X 200	L+	EC-L
6 X 80	BVS806	2 X 250	L+	EC-L
8 X 80	BVS808	3 X 200	L+	EC-L
10 X 80	BVS8010	3 X 250	L+	EC-L

Place tape into position in the mold ensuring the tape is firmly seated against the steel surface. The use of a C clamp to hold the mold against the surface is recommended.

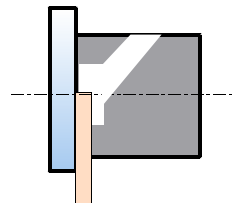

Tape to Rod

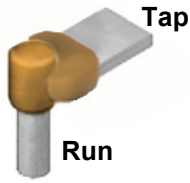

BGR

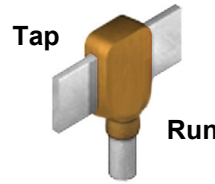

BGRT

A(Run)	B(Tap)	Mold Code	Weld Metal	Price Key	Handle Clamp
	2 x 20	BGR12202	65	M	EC-M
	2 X 25	BGR12252	65	M	EC-M
	2 X 30	BGR12302	90	M	EC-M
1/2 inch (12.7mm)	3 X 20	BGR12203	90	M	EC-M
	3 X 25	BGR12253	90	M	EC-M
	3 X 30	BGR12303	90	M	EC-M
	3 X 40	BGR12403	90	M	EC-M
	3 X 50	BGR12503	115	H	EC-M
	4 X 20	BGR12204	90	M	EC-M
	4 X 25	BGR12254	90	M	EC-M
	2 X 30	BGR14302	115	M	EC-M
	3 X 20	BGR14203	90	M	EC-M
	3 X 25	BGR14253	90	M	EC-M
	3 X 30	BGR14303	115	H	EC-M
	3 X 40	BGR14403	115	H	EC-M
	3 X 50	BGR14503	150	H	EC-M
	4 x 20	BGR14204	90	M	EC-M
	4 X 25	BGR14254	115	H	EC-M
5/8 inch (14.2mm)	5 X 25	BGR14255	115	H	EC-M
	5 X 30	BGR14305	150	H	EC-M
	5 X 40	BGR14405	150	H	EC-M
	5 X 50	BGR14505	200	H	EC-M
	2 X 30	BGR17302	150	H	EC-M
	3 X 20	BGR17203	115	H	EC-M
	3 X 25	BGR17253	150	H	EC-M
	3 X 30	BGR17303	150	H	EC-M
	3 X 40	BGR17403	200	H	EC-M
	3 X 50	BGR17503	2 X 150	J	EC-L
3/4 inch (17.2mm)	4 x 20	BGR17204	150	H	EC-M
	4 X 25	BGR17254	150	H	EC-M
	5 X 25	BGR17255	150	H	EC-M
	5 X 30	BGR17305	200	H	EC-M
	5 X 40	BGR17405	200	H	EC-M
	5 X 50	BGR17505	2 X 150	J	EC-L

Place the rod and tape into position in the mold. Ensure the tape butt to rod.

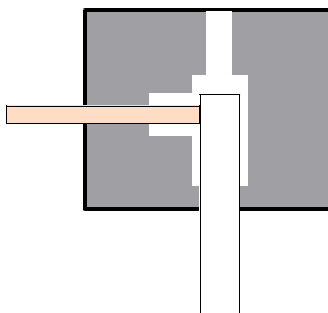

A(Run)	B(Tap)	Mold Code	Weld Metal	Price Key	Handle Clamp
	2 x 20	BGRT12202	90	H	EC-M
	2 X 25	BGRT12252	90	H	EC-M
	2 X 30	BGRT12302	115	H	EC-M
	3 X 20	BGRT12203	90	H	EC-M
	3 X 25	BGRT12253	115	H	EC-M
	3 X 30	BGRT12303	115	H	EC-M
1/2 inch [12.7mm]	3 X 40	BGRT12403	115	H	EC-M
	3 X 50	BGRT12503	200	H	EC-M
	4 X 20	BGRT12204	90	H	EC-M
	4 X 25	BGRT12254	115	H	EC-M
	4 X 30	BGRT12304	115	H	EC-M
	2 X 30	BGRT14302	115	H	EC-M
	3 X 20	BGRT14203	90	H	EC-M
	3 X 25	BGRT14253	115	H	EC-M
	3 X 30	BGRT14303	115	H	EC-M
	3 X 40	BGRT14403	150	H	EC-M
	3 X 50	BGRT14503	200	H	EC-M
	4 x 20	BGRT14204	90	H	EC-M
5/8 inch [14.7mm]	4 X 25	BGRT14254	115	H	EC-M
	4 X 30	BGRT14304	150	H	EC-M
	5 X 25	BGRT14255	115	H	EC-M
	5 X 30	BGRT14305	150	H	EC-M
	5 X 40	BGRT14405	200	H	EC-M
	5 X 50	BGRT14505	200	H	EC-M
	2 X 20	BGRT17202	150	H	EC-M
	2 X 30	BGRT17302	150	H	EC-M
	3 X 20	BGRT17203	150	H	EC-M
	3 X 25	BGRT17253	150	H	EC-M
	3 X 30	BGRT17303	150	H	EC-M
	3 X 40	BGRT17403	200	H	EC-M
	3 X 50	BGRT17503	2 X 150	J	EC-L
3/4 inch [17.2mm]	4 X 20	BGRT17204	150	H	EC-M
	4 X 25	BGRT17254	200	H	EC-M
	5 X 25	BGRT17255	150	H	EC-M
	5 X 30	BGRT17305	200	H	EC-M
	5 X 40	BGRT17405	200	H	EC-M
	5 X 50	BGRT17505	2 X 150	J	EC-L

Place the rod and tape into position in the mold. The tape should be positioned on top of the rod.

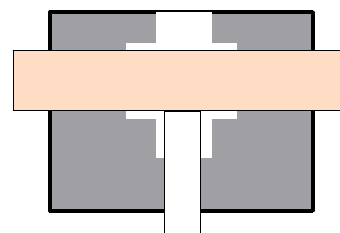

Cable to Rebar

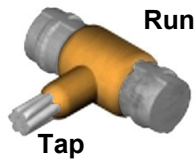

HCHRT

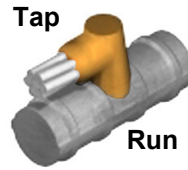

HCHRZ

A(Run)	B(Tap)	Mold Code	Weld Metal	Price Key	Handle Clamp
	25	HCHRT1325	90	M	EC-M
D13	35	HCHRT1335	90	M	EC-M
#4	50	HCHRT1350	115	M	EC-M
	70	HCHRT1370	115	M	EC-M
	95	HCHRT1395	150	H	EC-M
	25	HCHRT1625	90	M	EC-M
	35	HCHRT1635	90	M	EC-M
D16	50	HCHRT1650	115	M	EC-M
#5	70	HCHRT1670	150	H	EC-M
	95	HCHRT1695	150	H	EC-M
	120	HCHRT16120	150	H	EC-M
	150	HCHRT16150	200	H	EC-M
	185	HCHRT16185	200	H	EC-M
	240	HCHRT16240	250	H	EC-M
	35	HCHRT1935	115	M	EC-M
D19	50	HCHRT1950	115	M	EC-M
#6	70	HCHRT1970	150	H	EC-M
	95	HCHRT1995	150	H	EC-M
	120	HCHRT19120	200	H	EC-M
	240	HCHRT19240	2 x 150	M+	EC-L
	35	HCHRT2235	115	M	EC-M
D22	50	HCHRT2250	115	M	EC-M
#7	70	HCHRT2270	150	H	EC-M
	95	HCHRT2295	150	H	EC-M
	35	HCHRT2535	115	M	EC-M
	50	HCHRT2550	115	M	EC-M
D25	70	HCHRT2570	150	H	EC-M
#8	95	HCHRT2595	150	H	EC-M
	120	HCHRT25120	250	H	EC-M
	150	HCHRT25150	2 x 150	M+	EC-L
	240	HCHRT25240	2 x 150	M+	EC-L
	35	HCHRT3235	115	M	EC-M
	50	HCHRT3250	150	H	EC-M
D32	70	HCHRT3270	200	H	EC-M
#10	95	HCHRT3295	200	H	EC-M
	120	HCHRT32120	250	H	EC-M
	240	HCHRT32240	2 x 200	L+	EC-L

A(Run)	B(Tap)	Mold Code	Weld Metal	Price Key	Handle Clamp
	16	HCHRZ1P16	45	M	EC-M
	25	HCHRZ1P25	45	M	EC-M
	30	HCHRZ1P30	45	M	EC-M
20-40	35	HCHRZ1P35	45	M	EC-M
mm	50	HCHRZ1P50	90	M	EC-M
	70	HCHRZ1P70	90	M	EC-M
	95	HCHRZ1P95	115	M	EC-M
25-40	120	HCHRZ1P120	115	M	EC-M
mm	150	HCHRZ1P150	150	H	EC-M
	185	HCHRZ1P185	200	H	EC-M
32-40	240	HCHRZ1P240	200	H	EC-M
mm	300	HCHRZ1P300	250	H	EC-M

For rebar 16size or less, Use shims packing. Warp shim packing around rebar below area of weld.

For rebar size over 16, use felt packing. Place felt packing over rebar with lognest portion of packing hole running vertically.

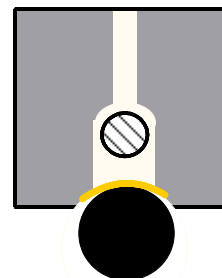
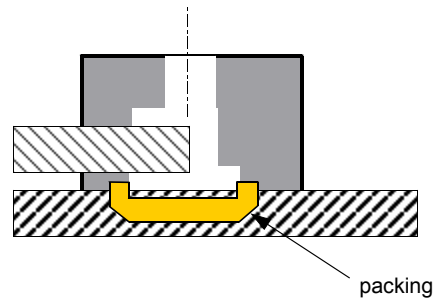

Place the cable and rebar into position in the mold. The use of fiber string is recommended for packing.

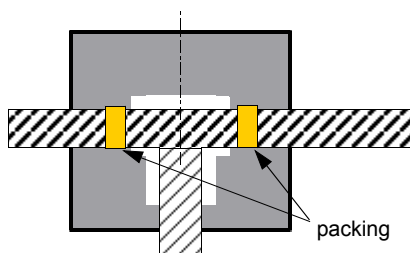

Cable to Rebar

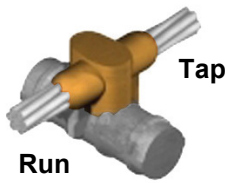

HCHRX

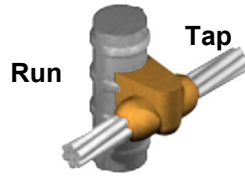

HCVRX

A(Run)	B(Tap)	Mold Code	Weld Metal	Price Key	Handle Clamp
	25	HCHRX1P25	65	M	EC-M
	30	HCHRX1P30	90	M	EC-M
20-40	35	HCHRX1P35	90	M	EC-M
mm	50	HCHRX1P50	115	M	EC-M
	70	HCHRX1P70	115	M	EC-M
	95	HCHRX1P95	150	H	EC-M
25-40	120	HCHRX1P120	150	H	EC-M
mm	150	HCHRX1P150	200	H	EC-M
	185	HCHRX1P185	250	H	EC-M
32-40	240	HCHRX1P240	2 x 200	J	EC-L
mm	300	HCHRX1P300	2 x 200	J	EC-L

A(Run)	B(Tap)	Mold Code	Weld Metal	Price Key	Handle Clamp
	16	HCVRX2P16	90	H	EC-M
	25	HCVRX2P25	90	H	EC-M
	30	HCVRX2P30	90	H	EC-M
20-40	35	HCVRX2P35	90	H	EC-M
mm	50	HCVRX2P50	115	H	EC-M
	70	HCVRX2P70	115	H	EC-M
	95	HCVRX2P95	150	R	EC-M
25-40	120	HCVRX2P120	150	R	EC-M
mm	150	HCVRX2P150	200	M+	EC-L
	185	HCVRX2P185	250	M+	EC-L
32-40	240	HCVRX2P240	2 x 200	M+	EC-L
mm	300	HCVRX2P300	2 x 200	M+	EC-L

Place the cable and rebar into position in the mold. The use of packing is recommended.

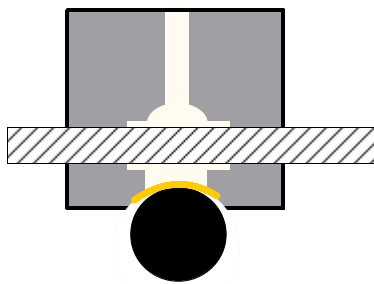
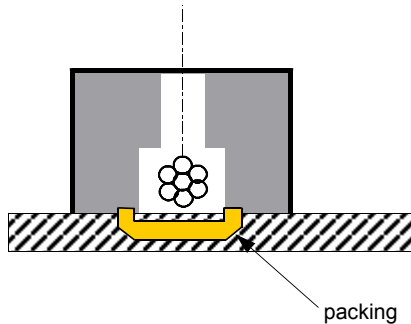

Place the cable and rebar into position in the mold. The use of packing sealer is recommended. Use C-clamp ET-014 and vice grip plier to hold the mold.

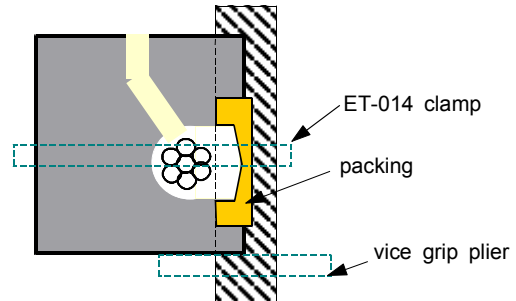

Cable to Rebar



A(Run)	B(Tap)	Mold Code	Weld Metal	Price Key	Handle Clamp
13mm	25	HCVR1325	90	J	EC-M
	35	HCVR1335	90	J	EC-M
	50	HCVR1350	115	J	EC-M
	70	HCVR1370	115	J	EC-M
	95	HCVR1395	150	J	EC-M
16mm	25	HCVR1625	90	J	EC-M
	35	HCVR1635	90	J	EC-M
	50	HCVR1650	115	J	EC-M
	70	HCVR1670	150	J	EC-M
	95	HCVR1695	150	J	EC-M
	120	HCVR16120	200	J	EC-M
18mm	35	HCVR1835	115	J	EC-M
	50	HCVR1850	115	J	EC-M
	70	HCVR1870	150	J	EC-M
	95	HCVR1895	150	J	EC-M
	240	HCVR18240	2 X 150	L+	EC-L
22mm	35	HCVR2235	115	J	EC-M
	50	HCVR2250	115	J	EC-M
	70	HCVR2270	150	J	EC-M
	95	HCVR2295	150	J	EC-M
25mm	35	HCVR2535	115	J	EC-M
	50	HCVR2550	115	J	EC-M
	70	HCVR2570	150	J	EC-M
	95	HCVR2595	150	J	EC-M
32mm	35	HCVR3235	115	J	EC-M
	50	HCVR3250	150	J	EC-M
	70	HCVR3270	200	J	EC-M
	95	HCVR3295	200	J	EC-M
36mm	35	HCVR3635	115	J	EC-M
	50	HCVR3650	150	J	EC-M
	70	HCVR3670	200	J	EC-M
	95	HCVR3695	200	J	EC-M

A(Run)	B(Tap)	Mold Code	Weld Metal	Price Key	Handle Clamp
	10	VCHRX3P10	65	J	EC-M
	16	VCHRX3P16	65	J	EC-M
	25	VCHRX3P25	90	J	EC-M
20-40	35	VCHRX3P35	90	J	EC-M
mm	50	VCHRX3P50	115	M+	EC-M
	70	VCHRX3P70	115	M+	EC-M
	95	VCHRX3P95	150	M+	EC-M
25-40	120	VCHRX3P120	150	M+	EC-M
mm	150	VCHRX3P150	150	M+	EC-M
	185	VCHRX3P185	150	M+	EC-M

Place the cable and rebar into position in the mold.
The use of packing sealer is recommended.
Use C-clamp ET-014 and vise grip plier to hold the mold.

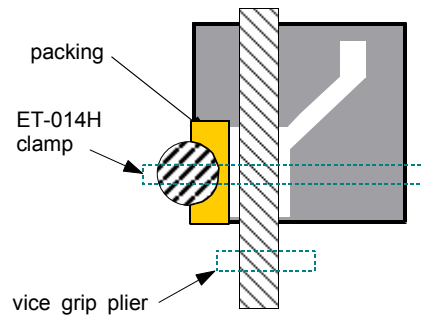

Place the cable and rebar into position in the mold.
Ensure the mold is supported through the use of vice grip pliers or a clamp via fixing to the rebar.
The use of ceramic fiber string is recommended for packing.

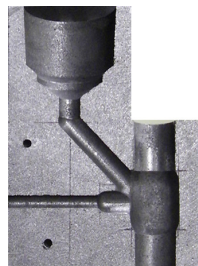
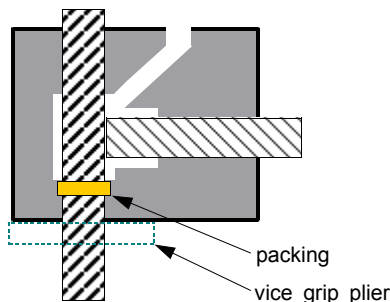

Cable to Earth Plate

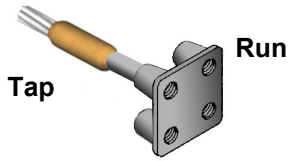

HE

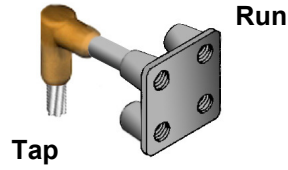

HER

A(Run)	B(Tap)	Mold Code	Weld Metal	Price Key	Handle Clamp
10.7	50	HE11/50	65	M	EC-M
	70	HE11/70	65	M	EC-M
	95	HE11/95	90	M	EC-M
	120	HE11/120	115	M	EC-M
	150	HE11/150	115	M	EC-M
12.7	70	HE13/70	90	M	EC-M
	95	HE13/95	90	M	EC-M
	120	HE13/120	115	M	EC-M
	150	HE13/150	115	M	EC-M
14.0	70	HE14/70	90	M	EC-M
	95	HE14/95	90	M	EC-M
	120	HE14/120	115	M	EC-M
	150	HE14/150	115	M	EC-M

A(Run)	B(Tap)	Mold Code	Weld Metal	Price Key	Handle Clamp
10.7	50	HER11/50	90	H	EC-M
	70	HER11/70	90	H	EC-M
	95	HER11/95	115	H	EC-M
	120	HER11/120	150	H	EC-M
	150	HER11/150	150	H	EC-M
12.7	70	HER13/70	115	H	EC-M
	95	HER13/95	115	H	EC-M
	120	HER13/120	150	H	EC-M
	150	HER13/150	150	H	EC-M
14.0	70	HER14/70	115	H	EC-M
	95	HER14/95	115	H	EC-M
	120	HER14/120	150	H	EC-M
	150	HER14/150	150	H	EC-M

Place the cable and stem of the earth plate into position in the mold with cable end butting to stem of the earth plate with 3mm gap under the center of the tap hole.

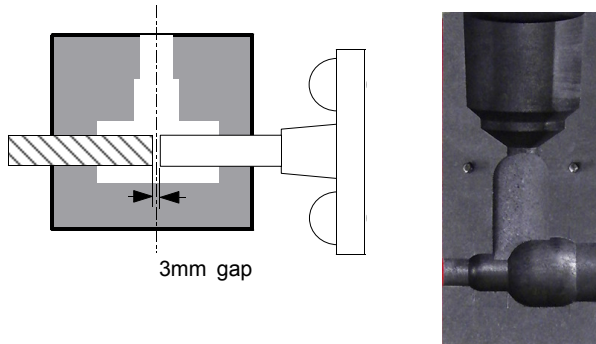

Place the earth plate stem and cable into position in the mold.

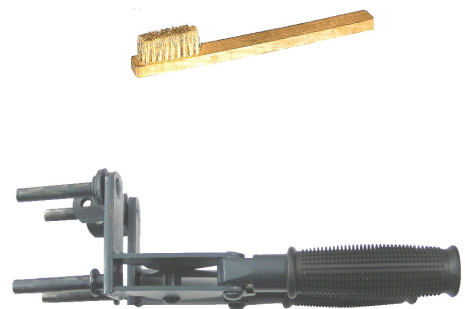
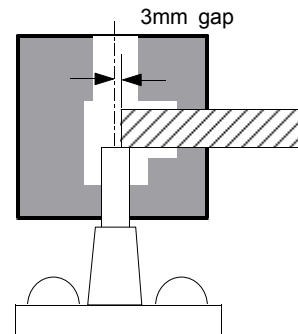

Cathodic Protection

Run

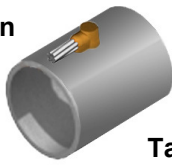

CHCI

Tap

A(Run)	B(Tap)	Mold Code	Weld Metal	Price Key	Handle Clamp
6	4" or Larger	CHCI6-A	15	F1	FF
	3/4"~3-1/2"	CHCI6-B	15	F1	FF
10	4" or Larger	CHCI10-A	15	F1	FF
	3/4"~3-1/2"	CHCI10-B	15	F1	FF
16	4" or Larger	CHCI16-0	15	F1	FF
	4"~5" pipe	CHCI5P-A	15	F1	FF
	3/4"~3-1/2"	CHCI16-B	15	F1	FF
5mm	6" or Larger	CHCI5P-0	15	F1	FF
	4"~5" pipe	CHCI5P-A	15	F1	FF
	3/4"~3-1/2"	CHCI5P-B	15	F1	FF

Tap

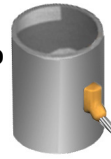

CVCI

Run

A(Run)	B(Tap)	Mold Code	Weld Metal	Price Key	Handle Clamp
6	12" or larger	CVCI6-A	15	F2	EC-S
	4"~10"	CVCI6-B	15	F2	EC-S
	3/4"~3-1/2"	CVCI6-C	15	F2	EC-S
10	12" or larger	CVCI10-A	15	F2	EC-S
	4"~10"	CVCI10-B	15	F2	EC-S
	3/4"~3-1/2"	CVCI10-C	15	F2	EC-S
16	12" or larger	CVCI16-A	25	F2	EC-S
	5"~10"	CVCI16-B	25	F2	EC-S
	2"~4"	CVCI16-C	25	F2	EC-S
	3/4"~1-1/2"	CVCI16-D	25	F2	EC-S
5mm	12" or larger	CVCI5P-A	25	F2	EC-S
	5"~10"	CVCI5P-B	25	F2	EC-S
	2"~4"	CVCI5P-C	25	F2	EC-S
	3/4"~1-1/2"	CVCI5P-D	25	F2	EC-S

Run

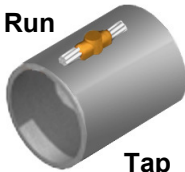

CHCJ

Tap

A(Run)	B(Tap)	Mold Code	Weld Metal	Price Key	Handle Clamp
6	4" or Larger	CHCJ6-A	25	F1	FF
	3/4"~3-1/2"	CHCJ6-B	25	F1	FF
10	4" or Larger	CHCJ10-A	25	F1	FF
	3/4"~3-1/2"	CHCJ10-B	25	F1	FF
16	6" or Larger	CHCJ16-0	32	F1	FF
	4"~5" pipe	CHCJ16-A	32	F1	FF
	3/4"~3-1/2"	CHCJ16-B	32	F1	FF
5mm	6" or Larger	CHCJ5P-0	32	F1	FF
	4"~5" pipe	CHCJ5P-A	32	F1	FF
	3/4"~3-1/2"	CHCJ5P-B	32	F1	FF

Tap

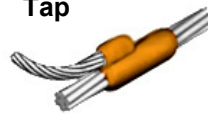

CHPZ

Run

A(Run)	B(Tap)	Mold Code	Weld Metal	Price Key	Handle Clamp
16	6	CHPZ16-6	25	F2	EC-S
	10	CHPZ16-10	25	F2	EC-S
	16	CHPZ16-16	25	F2	EC-S
25	6	CHPZ25-6	32	F2	EC-S
	10	CHPZ25-10	32	F2	EC-S
	16	CHPZ25-16	32	F2	EC-S
	25	CHPZ25-25	32	F2	EC-S
35	6	CHPZ35-6	32	F2	EC-S
	10	CHPZ35-10	32	F2	EC-S
	16	CHPZ35-16	45	F2	EC-S
	25	CHPZ35-25	45	F2	EC-S
	35	CHPZ35-35	45	F2	EC-S
50	6	CHPZ50-6	45	F2	EC-S
	10	CHPZ50-10	45	F2	EC-S
	16	CHPZ50-16	45	F2	EC-S
	25	CHPZ50-25	45	F2	EC-S
	35	CHPZ50-35	65	M	EC-M
70	6	CHPZ70-6	65	M	EC-M
	10	CHPZ70-10	65	M	EC-M
	16	CHPZ70-16	65	M	EC-M
	25	CHPZ70-25	65	M	EC-M
	35	CHPZ70-35	90	M	EC-M

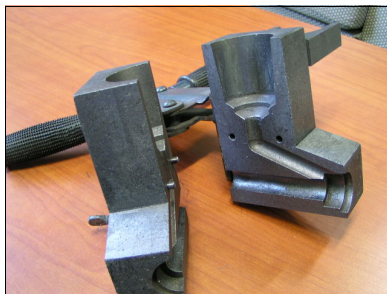

Cable to Rail

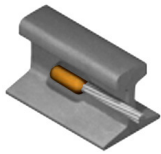

HCR

Conductor	Mold Code	Weld Metal	Price Key	Handle Clamp
3/16" Dia	HCR3/16L(R)	25	R	HCR-TL
5/16" Dia	HCR5/16L(R)	25	R	HCR-TL
10	HCR10L(R)	45	R	HCR-TL
16	HCR16L(R)	45	R	HCR-TL
25	HCR25L(R)	45	R	HCR-TL
35	HCR35L(R)	45	R	HCR-TL
50	HCR50L(R)	65	R1	HCR-TM
70	HCR70L(R)	90	R1	HCR-TM
95	HCR95L(R)	115	R1	HCR-TM
120	HCR120L(R)	115	R1	HCR-TM
150	HCR150L(R)	150	R2	HCR-T

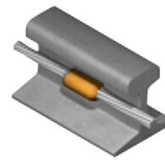

HCHR

Conductor	Mold Code	Weld Metal	Price Key	Handle Clamp
10	HCHR10	65	R1	HCR-TM
16	HCHR16	65	R1	HCR-TM
25	HCHR25	65	R1	HCR-TM
35	HCHR35	65	R1	HCR-TM
50	HCHR50	90	R1	HCR-TM
70	HCHR70	115	R1	HCR-TM
95	HCHR95	150	R2	HCR-T
120	HCHR120	150	R2	HCR-T
150	HCHR150	200	R2	HCR-T

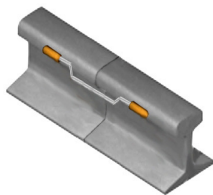

HRB

Conductor	Mold Code	Weld Metal	Price Key	Handle Clamp
3/16" Dia	HRB 3/16L(R)	25	RR1	HRB-T1
5/16" Dia	HRB 5/16L(R)	25	RR1	HRB-T1
50 sq	HRB50L(R)	65	RR2	HRB-T2
70 sq	HRB70L(R)	90	RR2	HRB-T2
95 sq	HRB95L(R)	90	RR2	HRB-T2

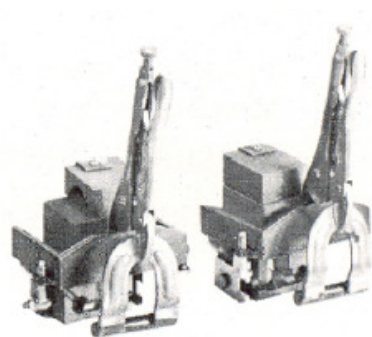

Korea EMI Technologies co.,Ltd.

KBN 130-81-30838

Address : 652-3 Jangam-ri, Majang-myeon
Icheon-sim, Gyeonggi-do, Korea
Phone : +82 (0) 31 633 1918
Fax : +82 (0) 31 633 1928
Email : info@emitech.co.kr
Web : www.emitech.co.kr